



भारतीय प्रबंध संस्थान बेंगलूर
INDIAN INSTITUTE OF MANAGEMENT
BANGALORE

WORKING PAPER NO: 313

**System Dynamics Integrative Modeling in the Diffusion
Dynamics of Indian Telecom Sector**

BY

Dr. Sanjay Bhushan

*Visiting Research Faculty, IIM Bangalore
Dept. of Management, Faculty of Social Sciences
Dayalbagh Educational Institute (Deemed University)
Dayalbagh, Agra 282 005 (UP)
bhushan.sanjay@rediffmail.com*

Janat Shah

*Professor in Operations
Supply Chain Management Centre
Indian Institute of Management Bangalore
Bannerghatta Road, Bangalore – 5600 76
Ph: 080-26993079
janat@iimb.ernet.in*

System Dynamics Integrative Modeling of the Diffusion Dynamics of Indian Telecom Sector

*Sanjay Bhushan, Janat Shah

ABSTRACT

In recent times, India has emerged as one of the fastest growing telecom markets in the world and witnessed a telecommunication revolution brought about by a collaboration of government, industry, and the scientific community. From a situation where an applicant had to wait three years to obtain a telephone connection to a position where telephone companies are wooing consumers, it has been a success of indigenous technology development and effective diffusion management.

Derived from the insight gained in the course of literature research and interaction with industry experts, in this paper, a system dynamics integrated model of Indian telecommunication sector (Mobile Telephony) has been calibrated to demonstrate the nature of interactions among system variables and the resultant outcome which assume degrees of importance at different stages of the diffusion/adoption process in the Indian telecom sector. From a supply chain perspective, the study has encompassed system modeling of the entire 'supply-line' of Telecom diffusion i.e. Supply-side dynamics (R&D, Infrastructure, Production & Promotion), Adoption-dynamics (Potential Adopters, Rate of Adoption and Number of Adopters) and Market-side dynamics (Subscription demand, Revenue and Profitability)

The work done here proves how the application of system dynamics modeling and simulation can contribute in a meaningful way to improve the holistic understanding of the dynamic structural complexities and forces driving and arising from the supply line of telecom diffusion. Several model simulations show the potential of using system dynamics as a promising modeling approach to capture, integrate and predict the structural behavior of innovation diffusion process. In the end, a novel interface of neural net has been explored to perform sensitivity analysis and a scenario projection of multiple usage situations has also been conducted.

Key Words: System Modeling, System Dynamics, Innovation Diffusion & Supply Chain, Indian Telecom

***Dr. Sanjay Bhushan** is Lecturer (Sr. Scale) in the Dept. of Management, DEI, Dayalbagh and **Prof. Janat Shah** is Professor in Operations and associated with the SCMC, IIM Bangalore. This research is done under the MoU between the Supply Chain Management Centre, IIM Bangalore and the Dept. of Management, Dayalbagh Educational Institute (Deemed University), Dayalbagh, Agra. The authors acknowledge and express their gratitude to Prof. Sanjeev Swami, Head, Dept. of Management, Dayalbagh Educational Institute (Deemed University), Agra and Mr. Raj Kumar Upadhyaya, Dy. GM, BSNL for fruitful discussion and providing valued insight in the area of Telecom innovation diffusion .

INTRODUCTION:

Innovation can be attributed as a systemic and interactive process which is developed in a specific social, economic and institutional context. (Lundvall 1992; Morgan 1997). In a traditional business set up, innovation used to be a linear trajectory from new knowledge to new product and historically, the conventional approaches to innovation diffusion have tended to regard innovation as the product of research, and view its dissemination as a largely linear process confined to researchers, producers and target users. Contrary to this, systems approach places greater emphasis on the rapidly changing internal and external structural dynamics and on the importance of a diversity of key actors and the surrounding operating environment. Applied systems research addresses real world problems concerned with complex, unstructured, multidisciplinary, large scale systems which require acquiring information of the system and its components and environment which seek approximate solutions to precisely or imprecisely formulated problems (*Satsangi et al. 2001*)

Organization of the Paper:

In this paper, we endeavor to present a system dynamics framework to explain diffusion dynamics and associated dimensions for handling them in the Indian telecom sector. It is proposed to design a robust innovation model through the selection of appropriate set of decision variables based on real time observed values.

Section I covers a brief exposition accompanied by a consolidated tabular presentation of past studies and researches in the field of innovation diffusion inclusive of Telecom diffusion. In **Section II**, an integrative model structure with a modular dynamic hypothesis using system dynamics stock-flow framework has been parameterized, calibrated, validated and simulated. **Section III** begins with discussion of invoking the framework of soft computational neural nets to perform sensitivity analysis for selected set of control variables, covers scenario projection and ends with conclusion and direction for future research.

Section-I: Review of Literature and Conceptual Framework

The innovation diffusion model suggested by various researchers concerns to how innovations are spread. In this respect, diffusion is claimed to be the process through which an innovation spreads via communication channels over time among the members of a social system. (Rogers, 2003, Stoneman, 2002). Drawing from the diffusion of innovation theory, we normally come to infer that the new technology pursues a diffusion path illustrated by a logistic curve and it illustrates emergent behavior and feedback when aggregates of individual behavior scale up to a similar behavior on a system level (Rogers 2003).

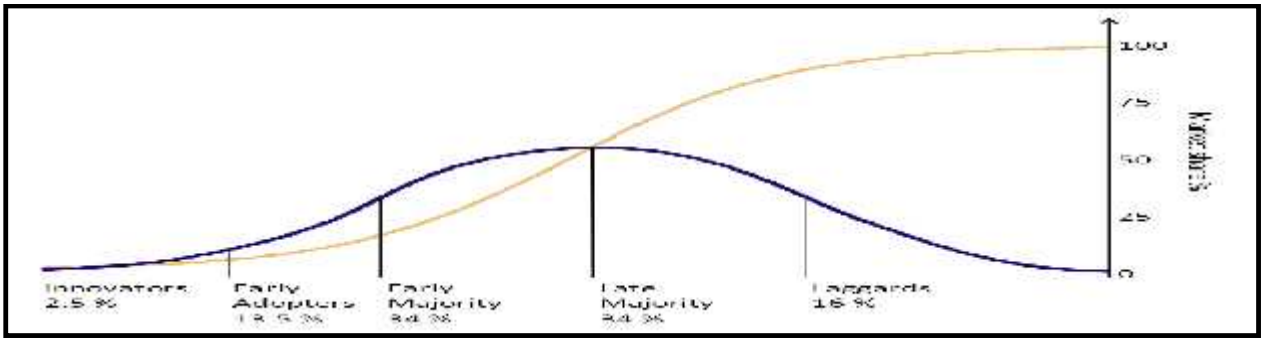

A Standard Diffusion Process Diagram

1.1. Past Studies and Problem Identification: (Refer Consolidated Table 1)

Many researches in the past in the area of innovation adoption and prediction have attempted to model the various structural aspects of innovation diffusion processes and properties of the product life cycle curve namely, the Bass Model, Gompertz Curve, the Pearl Curve, the Mansfield Model, the Blackman Model, the Fisher-Pry Model, the NSRL Model, the Non-Uniform Influence (NUI) Model, the Sharif-Kabir Model, the Weibull Distribution Model (or Sharif-Islam Model), and the Horsky Model. These models are now used widely for demonstrating and explaining technological changes and diffusion processes of new ideas (X. Tingyan 1990).

Standard Bass Model:

The Bass Diffusion Model propounded by Frank M. Bass and the later extensions of diffusion theory have been used extensively for market analysis and demand forecasting of new technologies. The Bass model itself, or variants of it, is broadly applicable to a wide range of diffusion and growth phenomena, and there is a much literature applying the Bass model and related models to innovation diffusion. The spread of a new product in a market can be characterized by the following Bass formula:

$$N_t = N_{t-1} + p(m - N_{t-1}) + q \frac{N_{t-1}}{m}(m - N_{t-1})$$

The three parameters of the Bass Diffusion Model to predict N_t (Number of adopters at time t) are: m = the market potential, p = the coefficient of innovation and q = the coefficient of imitation.

Subsequently, the Bass model and other generic innovation models have been subjected to several improvements (Mahajan and Wind 1986, Mahajan, Muller and Bass 1990, Maier 1995a). Renana (Renana et al. 2010) has also recognized the need to extend the scope of diffusion modeling, and update the metrics and data sources used therein. It has been widely believed that the nature of diffusion processes requires broadening the scope of diffusion modeling from focusing on interpersonal

communications to include other social interactions and suggested that development of such a framework and model would assist in deciphering the relative importance of each of the various growth drivers.

The following Table-1, presents a consolidated detail of past studies and literature review suggesting that structural variables do affect the diffusion process; and, there is a need to analyze further, theoretically and empirically, diffusion models that addresses this issue more comprehensively. It is paramount to know that innovation diffusion process might show tendencies to increase or decrease abruptly because many specific factors for the innovation 'supply chain' may cause interventions in the series and it is important to consider larger portfolio of structural variables which not only impact the overall nature of diffusion but, in turn, also get affected by the process and condition of diffusion/adoption itself. The later effect is equally significant in making prediction about future behavior of integrated components of diffusion system.

One can accomplish this by using Bass and Rogers' diffusion framework and expanding or integrating it with additional system variables to identify key structural relations. In this regard, it is evident that in the nature of things, the component functions of innovation system are interrelated and hence need coordinated handling and it would be desirable to look at the innovation diffusion system as a single unified system and optimize the efficiency of the system as a whole. This is precisely what a "Systems Approach" of innovation diffusion propounds.

1.2. Utility of System Dynamics in probing diffusion structural dynamics:

Graphic tools of System dynamics namely causal loops and flow diagrams offer powerful communicability between modeler and decision maker. It is prudent to make use of the multiple simulation experiments with the help of SD model for acquiring capability for alternative policy formulations (Satsangi et al2002). System dynamics framework also proves to be immensely useful to the innovation diffusion study examining structural complexities and disruptions in a holistic sense and this interface means an interesting alternative that allows structural complexity and dynamics to be shown which are not adequately handled by linear and equilibrium models.

Some approaches based on system dynamics applied to the Bass model can also be found in literature. Milling (1986a; 1996) first applied it to model innovation diffusion for a monopolistic market, considering several decision variables as endogenous elements. The coarse structure of the model is structurally identical to the mixed influence model developed by Bass. In contrast to the Bass model, Milling (1986a; 1996) explained imitative purchases through a combinatorial analysis and added a clear and understandable corporate model to map system elements. This monopolistic core structure serves as a fundamental basis for a series of different models for analyzing the consequences of varying decision variables, such as pricing policies, capacity investment, or production policies (Milling 1986b; 1987; 1989).

Table.1: SNAPSHOT OF REVIEW OF LITERATURE ON INNOVATION DIFFUSION (Part-I) :	
Authors	Theme of Research
Geroski, 2000	Key explanatory of rate of diffusion
Chatterjee and Eliashberg, 1990	Change of attitude to innovation
Malcolm Wright et al. 1995, Frank Maier 97	Means of innovation diffusion
Mansfield (1961), and Bass (1969), Bass 1980; Oster 1982; Baptista 1999, Geroski 2000, Fourt and Woodlock (1960)	Diffusion modeling
Yang 2001	Diffusion in Telecom and E-Commerce
Seung et al. 2006	Extension of Diffusion Model
Milling 1986b; 1987; 1989; 1996; Maier 1995a, 1997	Broader perspective of Innovation diffusion and need of combinational analysis
Schumpeter 1947; Stoneman 1995	Process of innovation diffusion
Mahajan and Peterson (1985), Mahajan and Wind (1986), Mahajan, Muller and Bass (1990),	Improvement of generic diffusion model
Van den Bulte and Lilien, 1997, Van den Bulte and Stremersch, 2004, M. N. Sharif and C. Kabir (1976), M. N. Sharif and M. N. Islam (1980)	Non-linear estimation of Bass Model and revision of coefficients
Kalish [1995]	2 Differential equation extension of Bass Model
Hani 1996	Study of extension on US cable industry
Jones and Ritz, Freeman 1974, Barnett and Carrol (1995), Rogers (1995), Mohr, 1969, Moch and Morse, 1977, Kang 1999, Global Wind Energy Council 2009 report	Macro environmental influences and Adaptation
Frank Maier 1998, Zipkin P (1999) and Lee et al. 2000, Johnson, 2001	Stress on Feedback in diffusion process
Warner (1999), James Perry (1976)	Social and economic context of diffusion Substantive methodological change in diffusion research
Mohr, 1969, Moch and Morse, 1977	Empirical studies on diffusion
Renana, Mahajan & Muller (Renana 2010)	Need to update diffusion metrics and data sources
Mahajan Muller and Wind 2000; Mahajan Muller and Bass 1990	Multiple growth drivers of diffusion
Roshan et al. 2007	Affecting variables in diffusion process
Erik et al. 2009, Robinson et al. 1973; Dietzenbacher et al. 2005	Structural complexity and Non-linearity of supply chain of diffusion
Giddens 1990)	Geographical variation
Mitul Shah, Patent application number: 20090248488, USA	Complexity in system modeling of diffusion
Graziella et.al.)	Distortion of S-Shape of Diffusion
Barbara 2002, Graziella	Integrating array of variables in diffusion
La Londe 2005	Contingency planning due to uncertainties in diffusion
Skipper et al. 2009, Erik et al. 2008, Christopher 1992, Jain et al. (1991), Ho et al. (2000)	Supply chain disruption in diffusion

Forrester, 1999, Sterman, 2000, Sabine et al. 2005, Bhushan 2009, Kleijnen et al. 2003	Utility of system dynamics in complex system modeling and decision making
Milling (1986a; 1996), Sterman 2000	Application of system dynamics in diffusion modeling
Huang and Alfonso	Use of system dynamics in innovation forecasting
Speller USA	Methodological demonstration of system dynamics
Griliches 1980; Dixon 1980; Chatterjee & Eliashberg 1990	Demand-Supply equilibrium of Innovation
Zang 2004, Swaminathan et al.1998, Lee and Billington, James Lyneis. Young 1998), Rich and Ross 2006	Utility of simulation for control policies Contagion effect in Diffusion system
Frank Maier 98, David et al. 1991, Rich et al. 2006, Rogers 2003, Johnson, 2001 Enrico et al	Learning, observation and mutual interaction in diffusion Micro level feedback effect in diffusion
Rogers (1995), Skiadas, 2005, Young 1998) Willinger, Burns and Ulgen [2004]	Delay an dTime-dimension in diffusion process
Part-II : Literature on Supply-Market Side Innovation Dynamics	
Forrester 1961, Simon and Sebastian (1987), Rogers 1962, 1995, 2003, Christopher (1992, Ayers, 2002; Frances S. Berry, Andersen 1996), Pasinetti (1981), Carter (1990), Jeremy 2006, Lynn et al. (1996, p. 97, McEvily et al. 1999, (Freeman, 1987; Lundvall, 1992; Nelson, 1993; Edquist and Johnson, 1997, Freeman, 1991; Callon, 1994; McEvily Zaheer, 1999), Frances S. Berry, Temkin 2002 and Anderson and Lee 1999). Ravi Shankar et al, David Corkindale, Talukdar et al, 2002; Van den Bulte & Stremersch, 2004, McEvily and Zaheer (1999), Kumar and van Dissel 1996, Smith et al. 2007, Caputo <i>et al</i> 2002; Rogers 1995	Supply side dynamics of innovation and supply restriction, Network collaboration
L. Martin et al. 2001) and Soo Wook Kim, Cohen and Levinthal 1989, Branch 1974, Rosanna and Calantone 2002), Arthur 1989, Grabowski and Mueller 1978). Lundvall (2002)..	R&D perspective of innovation diffusion
Peter Danaher et al, Bass, Krishnan, and Jain 1994, Nair, Chintagunta, and Dube 2004; Tellis Yin and Niraj 2009	Marketing-Mix and promotion effect on Innovation diffusion
Nagurney et al., 2005, Lorenzoni, Guido 2009, Ashayeri et al, Kang et al. 1999, Yong et al. 2004, Hani 1996, Spekman and Davis (2004)	Demand Sensitivity and Demand management in Innovation
Carlsson et al. 2002, Rogers 1994, Graziella et al.), Lee Ho, Christopher and Lee, 2004, Mahler and Rogers (1999)	Attributes of demand, Critical Mass
Renana 2010 et al, Van den Bulte et al. 2004; Dekimpe et al. 1998, Michael Porter's 1990, Reichheld (1996)	Competition dynamics and substitution effect in Innovation
Stoneman 2002, Hannan & McDowell 1984; Rose & Joskow 1990, Graziella, Carlsson 2002, Freeman, 1988; Lundvall, 1988, 1992; Nelson, 1988, 1993; Max Ahman 2004, Soete and Arundel, 1995, Freeman, 1994; Blazejczak et al., 1999,	Macro externalities of innovation adoption and policy influence
Herald 2001, Comin 2004 & Hobijn, 2003, Graziella, Bretschneider 1980, Bemmaor's (1994), Rogers 1999, Economides (1991), Allen (1988)	Economic value, Infrastructure and Network externalities effect on innovation

If the traditional Bass model is reviewed from a system dynamics point of view, N and X , and N_t and X_t are the state variables of the system, the so-called market potential and the adopters of a product. If no capacity restrictions are assumed, the sales in a period consist of innovative and imitative demand. They reduce the market potential and increase the number of adopters. This sort of Bass model equation has already been transferred into a SD-version (Sterman 2000). The coarse structure of the mixed influence diffusion model from a system dynamics perspective can be shown below:

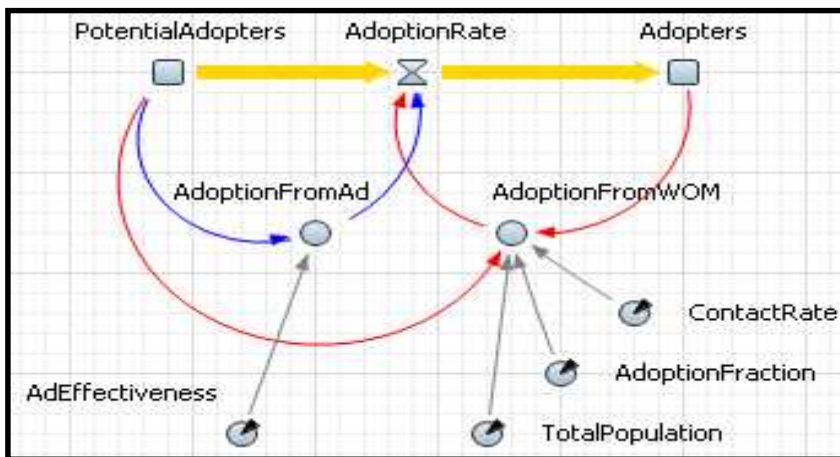

Figure 1: SD Framework of Bass Diffusion

A system dynamic model developed in the above manner can serve as a simulator for analyzing the consequences of different strategies. It is not suitable for dynamic optimization, but it allows an enhanced understanding of the influencing elements and the behavior they cause (Milling 1986b; 1987; 1989; 1996). It shows, for example, how innovation and imitation effect influence the dynamics of the diffusion process. Although the aim of SD models is the better understanding of the relationship between underlying structure and behavior of the feedback system, it can also — at least in principal — be used for forecasting (Huang et al. 2009). It must be noted here that, Feedback (interaction), which is the key differential factor of system dynamics from other modeling approaches, is what also makes an innovation systems dynamic.

System dynamics, thus, help showing how the traditional innovation models can be extended and modified to incorporate critical cause-effect relations leading to structural complexities and map their mutual interaction and try to formulate a dynamic hypothesis. The modeling framework used in this research captures structural variances and measures their performance through simulation under a parameterized setting. Several modular model simulations in the end show the potential of using system dynamics and neural network as a promising modeling combination in this regard.

Section II: Model Parameterization, Calibration and Simulation: Indian Telecom Sector

Derived from the insight gained in the course of literature research, a system dynamics integrated model of Indian telecommunication sector with a specific reference of Mobile Telephony has been calibrated and simulated to demonstrate the nature of interactions amongst variables which assume degrees of importance at different stages of the diffusion/adoption process in the Indian telecom sector. However, the availability of data remains an issue in order to capture the complete embedded dynamics of any system. Though, the model was evaluated for its consistency and compatibility across the sub-sectors but, due to the very nature of the case under study, this modeling step was difficult to execute with respect to historical consistency. Hence, the dimensions of only those parts were analyzed for which data were available. The choice was also to model the telecom innovation diffusion in a generic mode and subject to the assumption of an essentially homogenous population of potential adopters. This choice provides compatibility to the modeling approach of system dynamics which has normally been used for the aggregate level modeling problems.

2.1. Indian Telecom Scenario

The telecom services have been recognized the world-over as an important tool for socioeconomic development of a nation. Telecommunication is one of the prime support services needed for rapid growth and modernization of various sectors of the economy. It has become especially important in recent years because of enormous growth of information technology and its significant potential for the impact on the rest of the economy. The Telecom Sector, which has the multiplier effect on the economy, has a vital role to play in economy by way of contributing to the increased efficiency. In case of India, telecommunications is one of the few sectors in India, which has witnessed the most fundamental structural and institutional reforms since 1991.

As we see in recent times, country has emerged as one of the fastest growing telecom markets in the world; India has witnessed a telecommunication revolution brought about by a collaboration of government, industry, and the scientific community. From a situation where an applicant had to wait three years to obtain a telephone connection to a position where telephone companies are wooing consumers with rewards for over the counter connections, it has been a success of indigenous technology development and effective diffusion management. Within Telecom and among its various sub-segments, wireless or mobile segment has been the key contributor, offering a wide range of opportunities to provider and services to customers. Greater demand for better services and speed have made the market more competitive; as a result tariffs have been falling continuously across the board, making Indian tariffs one of the lowest in the world. Going forward, the sector is likely to achieve greater growth rates with a whole range of new services expected over next few years with the coming of 3G.

2.2. Data Collection and Model Construction:

The parameters of the base level-rate model were set using data collected from publicly available sources. Following Table-2 compiles together innovation indicator data of the observed and predicted values. These values have been obtained and cross verified through multiple sources, whereas some of them are based on estimates or projections

of what they may be in near future, given extraneous information. The consultation of several data sources has proven most useful in providing the information and expertise necessary to build the system model, and in particular to identify underlying feedback-feed forward loops.

2.3. Data Source:

- Press Release No. 20 /2010, TRAI, New Delhi, 2010 (www.trai.gov.in)
- Telecom Regulatory Authority of India (TRAI)
- Religare Institutional Research
- Stanford University and consulting firm BDA
- Frost & Sullivan industry analyst
- Nokia Research Group
- Business Monitor International, India
- Department of Telecommunications
- Telecommunications Consultants India Ltd.
- Private Investment Promotion in Indian Telecom
- RNCOS Industry Research Solutions
- Business Monitor International, India
- Duane-March10 TelecomTalk.info
- Optimus, ROA Group

Table 2: TELECOM SYSTEM DATA TABLE: Base case specification (t0=Year 2010, t15= year 2015, t10= Year 2020), Monetary value in Millions, Time Value in Years

Input Parameters	Value (Real & Projected)
Innovation Dynamics	
<ul style="list-style-type: none"> • Market Potential (Population) • Number of Subscribers • Growth rate • Coefficients of Growth* 	1.3 Billion (up to 2020) 584 Million @20% CAGR of Adopters Innovation: 0.0003, Imitation: 0.550
Supply Dynamics	
Research & Development (Equipment & Technology) <ul style="list-style-type: none"> • Revenue-Investment • R&D –GDP Ratio 	15% of Revenue Projected to grow 30% by 2012 1.3%
Operating Firms:	
<ul style="list-style-type: none"> • No. of Operators • Operators Density 	22 10 / Circle
Demand Dynamics	
Accumulated Telecom Revenue	\$43 Billion Projected to \$54 Billion in 2012@CAGR 18%
<ul style="list-style-type: none"> • ARPU (Average revenue Per User) 	GSM \$54.66/ annum (@Rs. 205/Month) CDMA \$26.4/ annum (@Rs. 99/Month)
<ul style="list-style-type: none"> • Decline Rate-ARPU: 	Annual Average 30% GSM 35% CDMA 26%
<ul style="list-style-type: none"> • ACPU (Average Cost Per User) 	\$26/annum

Competition:	
• GSM Share	68%
• CDMA Share	32%
• Competition Substitution/ Churn rate	6%
Market Share (Bharti Airtel)	26%
Macro Externalities Dynamics	
• Current Population	1.15 Billion
• Population growth rate	1.3%
• India's GDP	\$1.25 Trillion
• GDP Growth rate	CAGR 8.5% (2010-2020)
• Telecom Revenue-GDP Contribution	5.6% to GDP
	Projected GDP: 15.4 per cent by 2014
• Tele density-GDP Contribution Ratio	1: 3
• National Tele Density (Per 100 persons)	Overall: 52.74% (Mobile: 49.60%)
• Combined economic Value of Firms	\$100 Billion (Rs 4.5 Lakh Crore)
• Value Gain	2 Times Revenue
• Loss of Value (Due to License, regulations etc.)	6-7% /year, (3G-STEP , Yr. 2010=15%)
Infrastructure :	
• Accumulated Investment	\$76.8 billion
• Annual Investment:	@ 5% of Annual Gross Revenue (Universal Service Obligation -USO Levy)
• Number of Network Towers	2 Lac, Projected to 3.5 Lac by 2012
• Network Mortality/Retirement rate	3% per annum (Historical Mortality Analysis)

(*Talukdar et al. 2002)

Note that, since the values of coefficient of innovation and imitation were not known in a specific Indian context of diffusion and also it was not possible to derive it by means of regression as the information pertaining to influence of system factors are not entirely known, the parameterization was consequently a complex issue. Moreover, It has been found that the nonlinear estimation of static models such as the Bass model leads to downward biases in parameter values of market potential and the coefficient of innovation and an upward bias in the coefficient of imitation (Van den Bulte and Lilien, 1997). In order to overcome such a constraint, the parameters used as a basis for evaluating such effects were obtained by combining the p and q values found by Talukdar *et al* (2002) for developing countries. It is noteworthy that this derivation has been capable of almost successfully approximating the historical and prevalent diffusion pattern of Indian telecom sector with the adjustment of contact rate value. Here $q \gg p$, that is, in terms of attracting new subscribers, the internal influence(word-of-mouth communication) is much greater than the external influence(mass-media communication).That shows a brand's formation depends largely on the extent to which it receives good word-of-mouth from its own previous adopters.

2.4. Diffusion of Telecom: Dynamic Hypothesis and Level-Rate Model

The composite structure of the dynamic hypothesis with the interactive feed forward-feedback loops is shown in the telecom system model (Figure 2) below. Borrowed from the conceptual framework of innovation diffusion developed in the previous section and based upon the available observed values, the "slicing" of the telecom level-rate model into six 'sub-sectors' or 'concentration zones' has been done as follows:

STOCK-FLOW SYSTEM MODEL OF A JIAN TELECOM SECTOR (Base Year 2010, Projection: 2010-2015-2020)

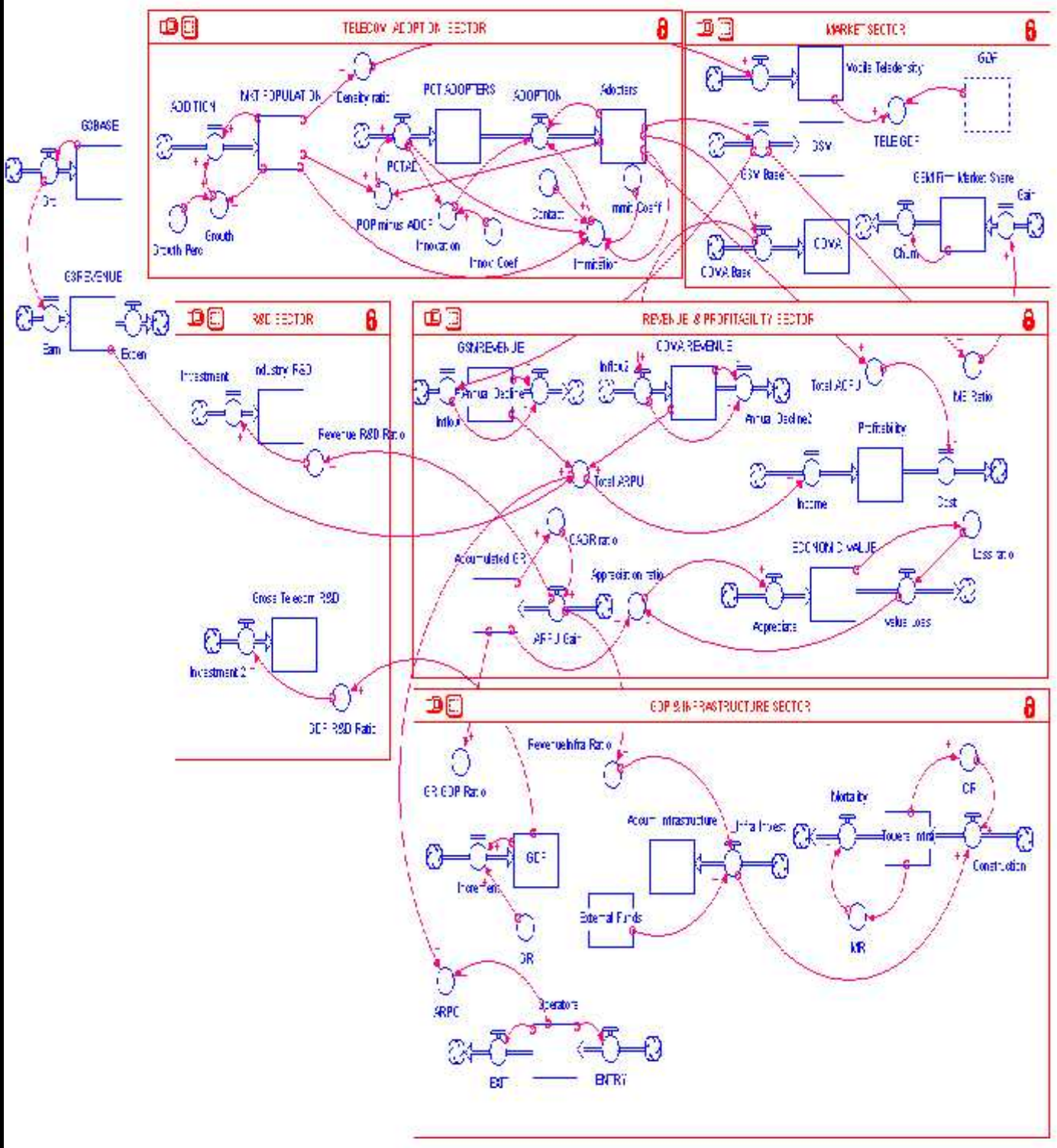

Figure 2: Integrative System Model

Table 3: Sub-sectors of Indian Telcom Diffusion Model

1. Telecom Adoption Sector	Population, Potential Adopters, Adoption process and Adopters
2. Market Sector	Tele-density, GSM, CDMA and GSM Firm's Market Share (a Leading mobile company)
3. Revenue & Profitability Sector (Telecom Equipment & technology)	Accumulated Gross Revenue, Sector Revenue, Economic Value and Profitability
4. GDP & Infrastructure Sector	GDP, Accumulated Infrastructure Investment, Towers infrastructure
5. Research & Development Sector	Gross Telecom Research & Development and Industrial R&D
6. Additional: 3G Sector Dynamics	3G Base & Revenue

The integrative model defines the blueprint architect for the level-rate modeling and represents a selective set of interactions prevalent in the Indian telecom sector. For ease of presentation only, the overall level-rate model has been split and discussed in sector frame together with the simulation results. This discussion has been carried out in two parts-

- I. Model Validation
- II. Simulation

2.5. Part-I: Validation of Calibrated Model Using Historical Data

The power of a modeling technique is a function of validity, credibility, and generality (Solberg 1992). Hence model validation is not an option but a necessity in a dynamic modeling scenario. It can be noted that due to the nature of the problem modeled and the lack of availability of historical data for all the sector modules used in the integrative model, only a part of the total model could be validated for its historical accuracy. We have chosen the primary and the base Innovation Diffusion sector of the integrative model for this purpose and generated simulation results for the duration 1999-2010 using historical data by invoking exactly the same modeling framework that has been calibrated for the integrative system model. This approach has proven the robustness of the main model by approximating the historical diffusion pattern and corresponding system behavior for the chosen period demonstrated by the curve estimation graph (Fig.3) and related values too.

Table 4: Validation Results (m=1000, p=0.0003, q=0.554)

ADOPTION Years	Observed Value (1999-2010)	Simulation Value (1999-2010)
1999-2000	1.88	1.80

2000-01	3.58	5.80
2001-02	6.5	11.90
2002-03	13	21.40
2003-04	33.6	36.24
2004-05	52.2	59.06
2005-06	90.14	94.36
2006-07	165.11	140.98
2007-08	261.07	233.40
2008-09	392	364.18
2009-10	584	566.39

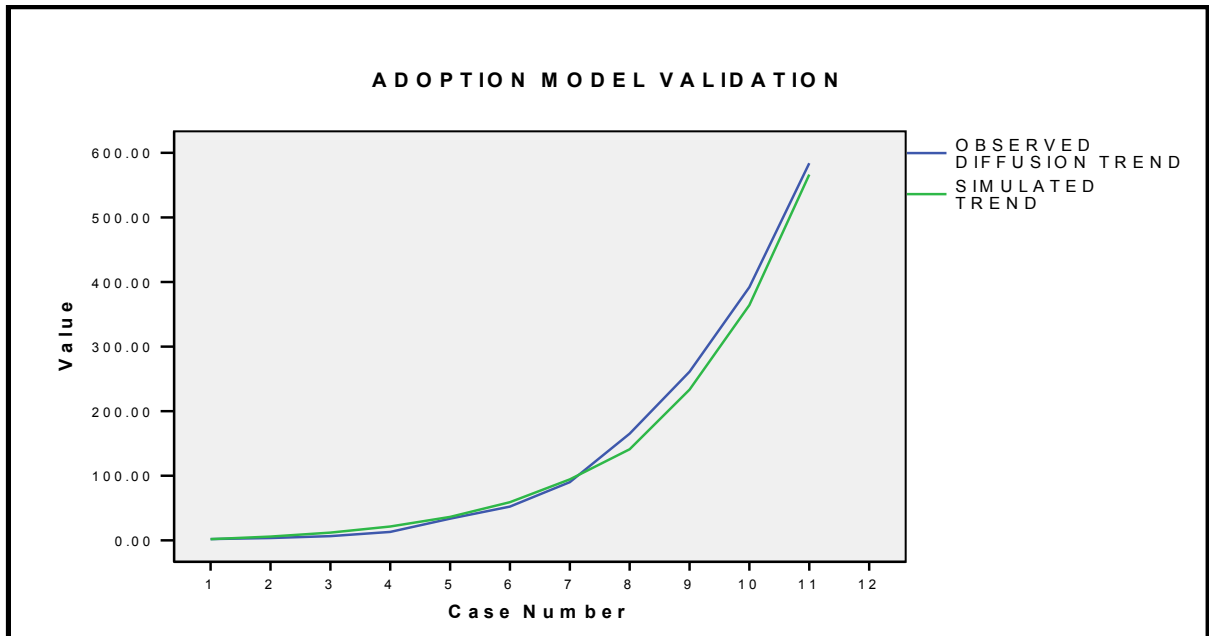

Figure 3: Comparison of Observed Values and Simulated values

This further proves the historical consistency and the structural validity of the calibrated system model. Robustness of the model has also been checked by simulating individual sub-sectors and individual modules before running the simulation for the entire model. We have also examined the model output for reasonableness under a variety of settings of the input parameters and also ensured that these parameter values have not been changed inadvertently at the end of simulation.

2.6. Part-II: Discussion: Simulation Results

Any problem that cannot be solved analytically given the complexities and non linearity find solace in simulation. It helps uncover and explain complex relationships between control policies and business processes (Zhang 2004). It is very important for organizations and its processes to have the abilities, both at design and operation level

to be responsive to different configurations to be tested against different realizations of future scenarios (Swaminathan et al.1998, Lee 2001, James Lyneis).

The integrated model framework and its test presented in this part has proven to be suitable to be extended for distributed simulation and thus supporting large-scale, complex analysis and design of integrative innovation model. Moreover, as most of the information has been taken from the prevailing scenario of the telecom sector to simulate the model behavior, it lends extra credibility and confidence in making future projections. In the present section, we discuss the simulation results performed on the base model together with some scenario projections. The base numerical simulation has been performed with parameters of the set-up as presented in Table I and set for the period 2010-2020. In the following paragraphs, we describe the flow of the simulation.

Simulation 1: Adoption Dynamics

First things first, in the Telecom Innovation Adoption Sector (Figure 5), a chain of interactions between Population, Potential adopters, Adoption and Adopters along with Innovation and Imitation trend has been simulated and one can observe how the feed forward-feedback pulses propagate smoothly through the chosen time-path creating a synchronized pattern of behavior. (Simulation Graph S1).

From the marketing perspective, adoption diffusion is projected to move towards stagnation starting from year 2013 onwards, showing a substantial decline in the aggregate number of potential adopters and the adopters, By the year 2015, the telecom market in India is projected to reach up to 1053.17 million users covering approx 84% of total Indian population (closing at 1246.15, Year 2015). In the next five year period i.e. 2015-2020, though, an extra 200 million new customers are projected to join in (taking total number of adopters to 1240 million), steeply down compared to more than 100 million new subscribers adding up every year during the period Year 2010-2013. However, the absolute number of adopters and potential adopters will keep on moving, albeit at a very slow rate, on account of increasing population (Market Potential projected to grow at CAGR 1.3). Inclusion of incremental population trend of a country and its ensuing effect over the number of adopters is a remarkable creative departure of our model from other diffusion models. Here, it is noteworthy that when we use the estimated GAGR value of Adopter's growth in India (i.e. CAGR 20%) estimated by TRAI and the other market agencies, in place of historical coefficient values, we arrive at approximate similar estimate (i.e. 1292 million subscribers by 2020).

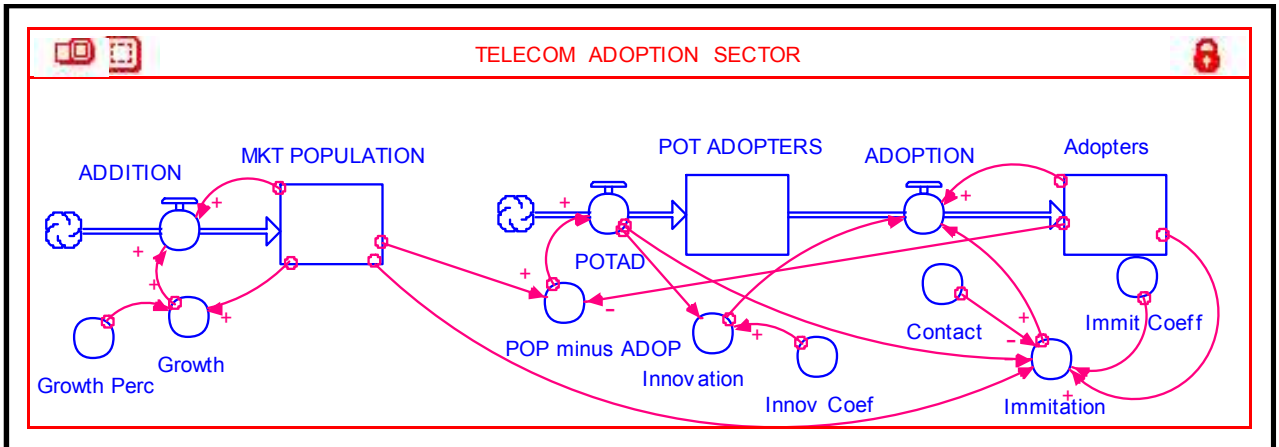

Figure-5 for Graph S1

In this module, one can also notice positive feedback loops between Market Population, Potential adopters, Adopters and Rate of adoption. However, as one moves along the adoption path, the respective stock values of potential adopters, innovation and imitation effects diminish (see GraphS1) indicating a negative feedback loop at work.

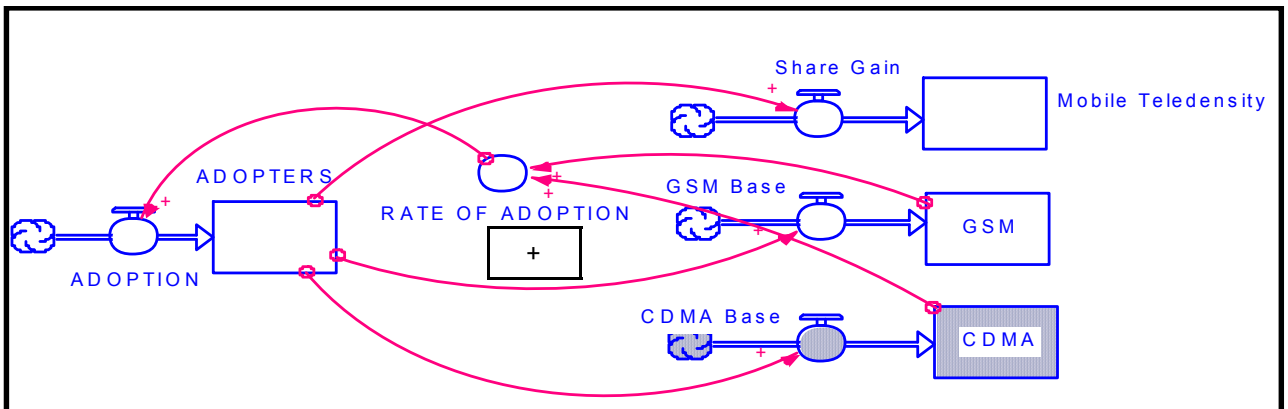

Figure-6 for Graph S2

Simulation 2: Market Dynamics

Moving to the Market Sector (Figure 6), we find the proportionate increment in the GSM-CDMA market share holding respectively a differential but steeping growth curve of market share initially before flattening out due to stagnation in adopter's volume which starts creeping from the 3rd year onwards. It also creates a positive feedback impact over the national telecom density which has an exponential growth slope as it represents accumulated number of subscribers over a period of time. This has also occurred due to a positive causal effect of market feedback to the total number of adopters at a given point of time. This market dynamics has also been collaborated with cumulatively increasing market share of a leading GSM operator in India having 26%

market share taken here as a sample example to depict the incremental growth of market share (Graph S2).

Simulation 3: Revenue Dynamics

As a consequential output of above diffusion dynamics, one can expect a corresponding propagation in the growth curves of individual revenue estimates for CDMA and GSM operators. It must however be mentioned that the revenue realization stock also has an outward flow of decline in revenue (estimated @30%) calculated as Adjusted Total ARPU (Average revenue per user) and which has effectively moderated the CDMA and GSM revenue curves as the time progresses (Graph S3). However, Telecom operators in India have something to cheer about. Seeing that the subscriber base continues to substantially increase in the coming 3-5 years, they would continue to make profit in spite of falling ARPUs. Moreover, it is not that a falling ARPU tells us that there is no growth; instead, ARPU is falling because there is growth.

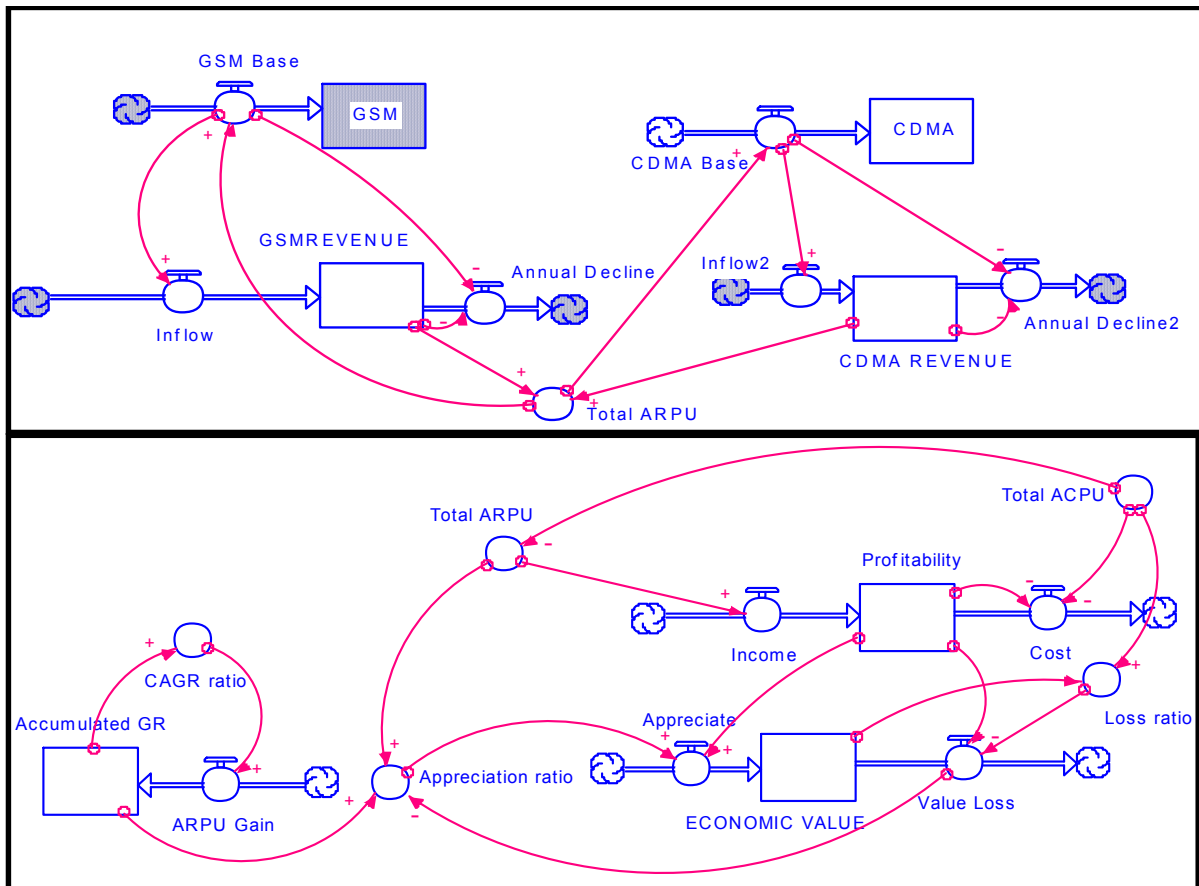
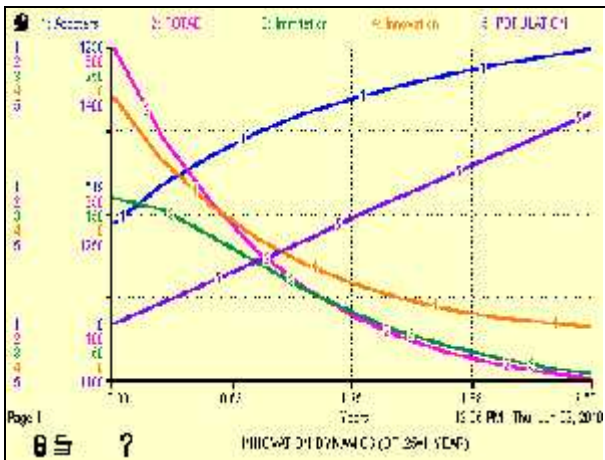

Figure-7 for Graph S3, S4, S5

Behaving as a contagion effect, related to this revenue sector, we can observe a gradually increasing but moderated Industrial Economic value of telecom as a whole (Graph S3 and S4) and one may take notice of the shift happening to Appreciation and loss curves at the first time point after Base 2009-10 i.e. at Year 2010-11, on account of

15% (\$15 Billion or Rs. 70,000 crore) direct outgo of the economic value to the industry due to spectrum allocation fees charged by the Indian government (Graph S4). This effect thus shifts the relative phase of appreciation ratio and loss ratio despite the slope of aggregate ARPU remaining unchanged rather appreciating (Graph S5) which is understandable due to the fact that new spectrum allocation will be supposedly fetching more subscription and revenue to the operators (official sources estimate it to be @250 per user at the volume of 60 million subscribers by the year 2013).



S1: ADOPTION DYNAMICS

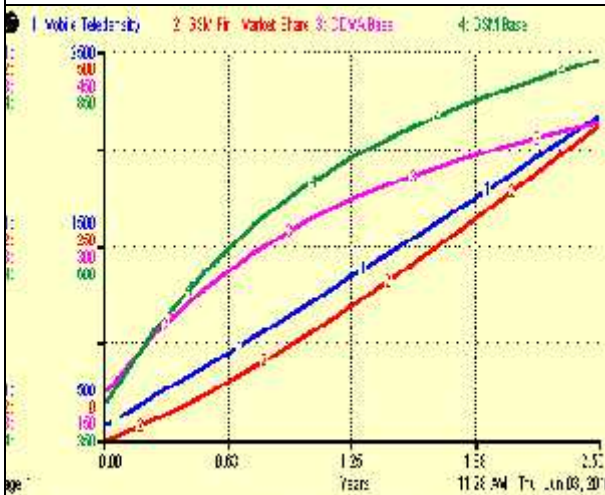

S2: MARKET DYNAMICS

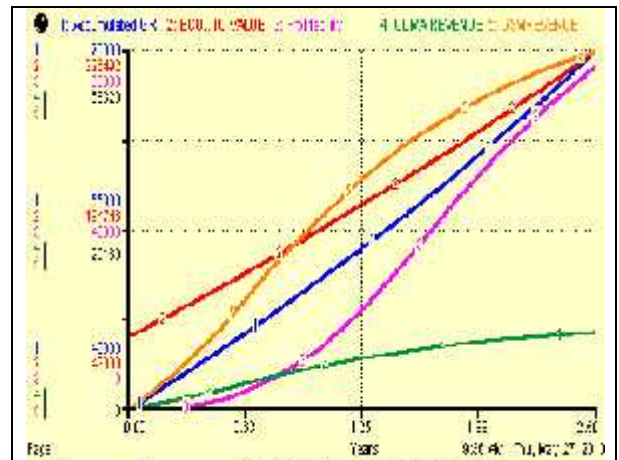

S3: PROFITABILITY & REVENUE DYNAMICS

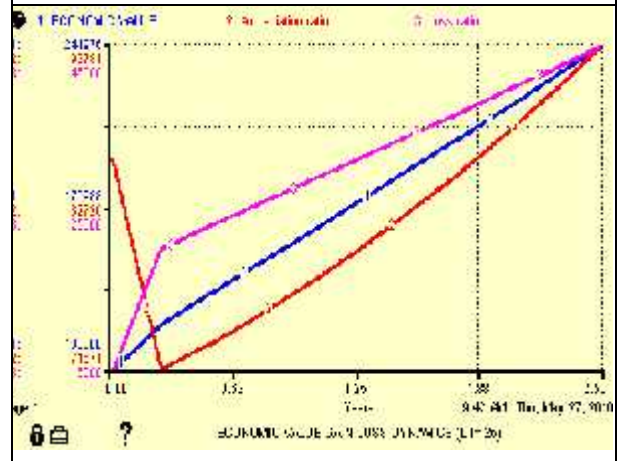

S4: ECONOMIC VALUE GAIN-LOSS

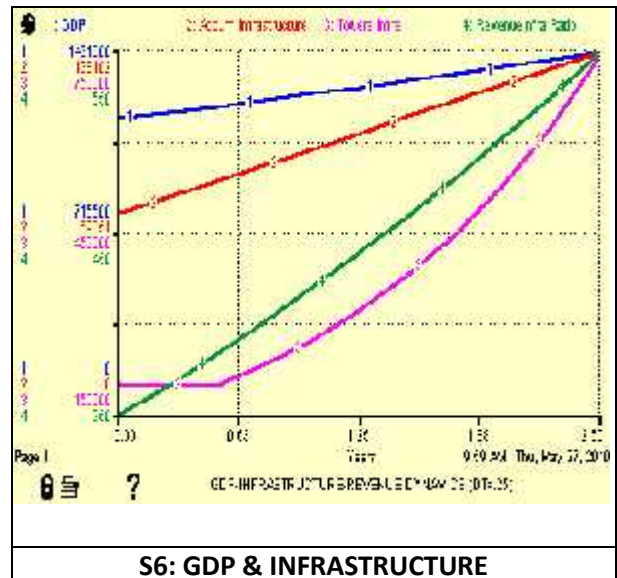
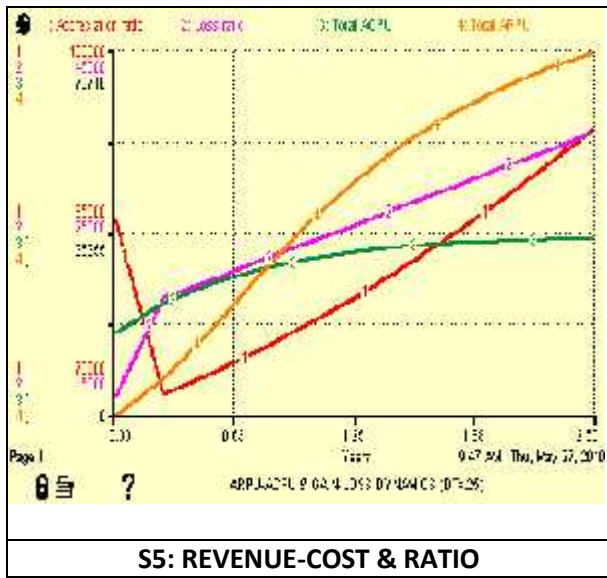

Simulation 4: External Dynamics

Coming to the GDP and Infrastructure sector, it is observed that Indian GDP will make steep gain beyond time point three (Year 2013) due to strong fundamental economic revival as projected by government sources and it would in turn presumably result in exponential growth of the overall infrastructural investments graph (Graph S6). This rise in the infrastructure can however be directly attributed to the contribution made by the Telecom Revenue sector (estimated value @5% per annum). We can thus see a positive feedback loop emerging between GDP-Revenue-Infrastructure sectors. Towers infrastructure which as of today stands at 2Lakh is also expected to mount up to 3.5lacs by 2012 in order to cope with the growing market requirement.

The telecom services have been recognized the world-over as an important tool for socio-economic development of a nation and has the multiplier effect on the economy, playing a vital role by way of contributing to the increased efficiency. Hence, so far as GDP-Revenue relation concerned, there is a strong positive feedback as depicted in the model below as GR-GDP ratio which is estimated to have contributed 5.6 % of total GDP in 2009-10 and expected to mount up to 15% by 2013 (Step Graph G8). This step effect has been deliberately shown to project the quantum of contribution made by telecom revenue towards national GDP. Added to it, as seen in the curve projection of Construction ratio (CR) and Mortality ratio (MR) for the Tower infrastructure (number of towers), it is projected to grow at a moderate frequency due to the 6-7% mortality factor calculated under mortality analysis. This has been demonstrated in Graph S7. As can be seen here, over a long horizon, technological obsolescence would result into higher MR which would in turn require more construction of new towers.

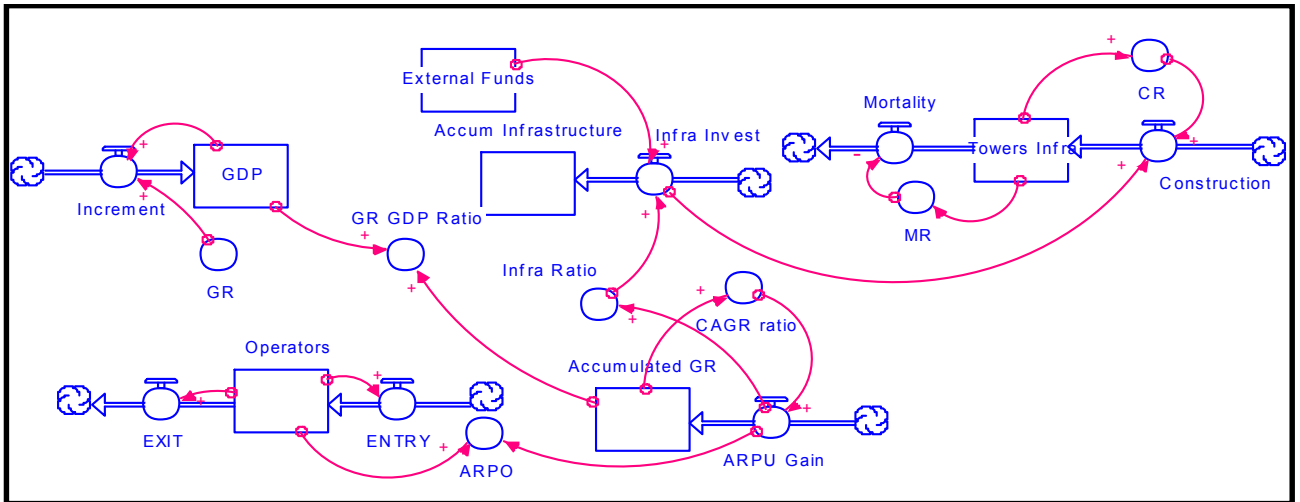
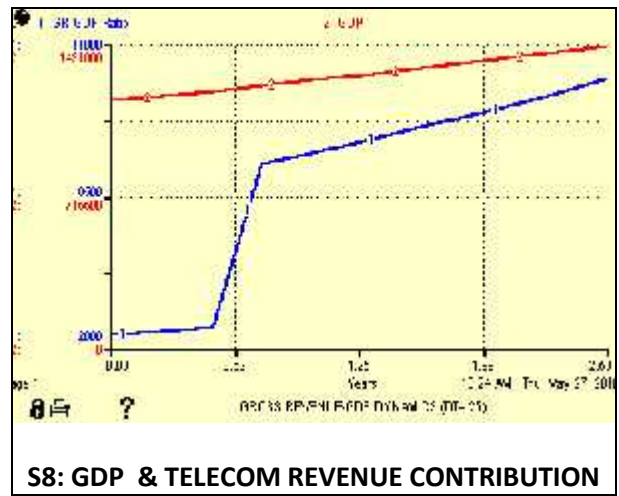
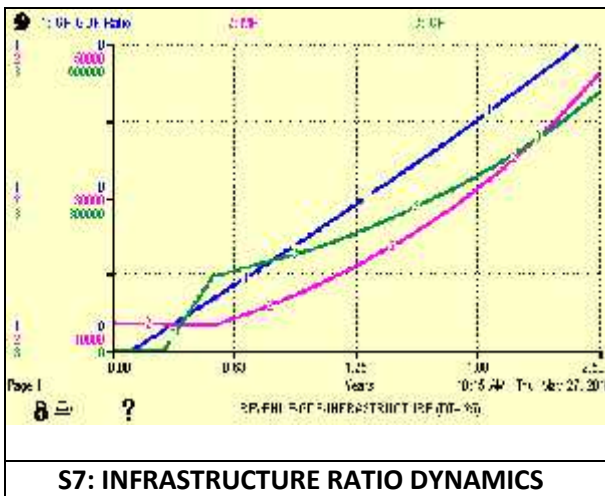
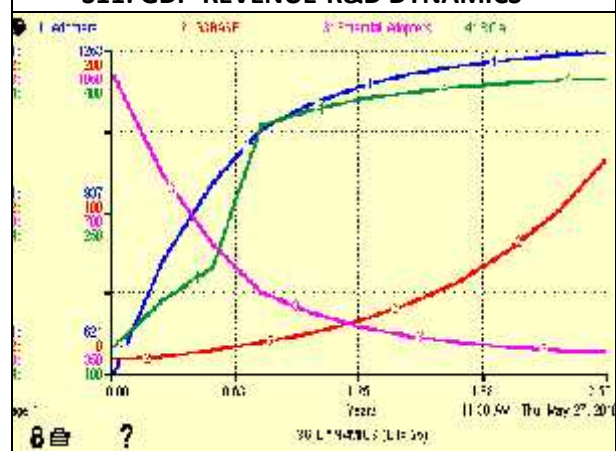
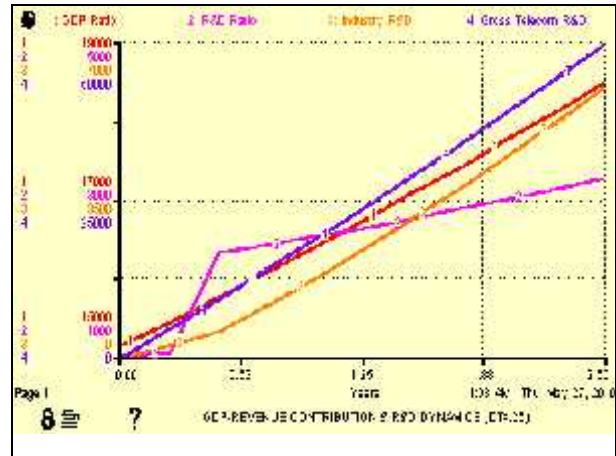
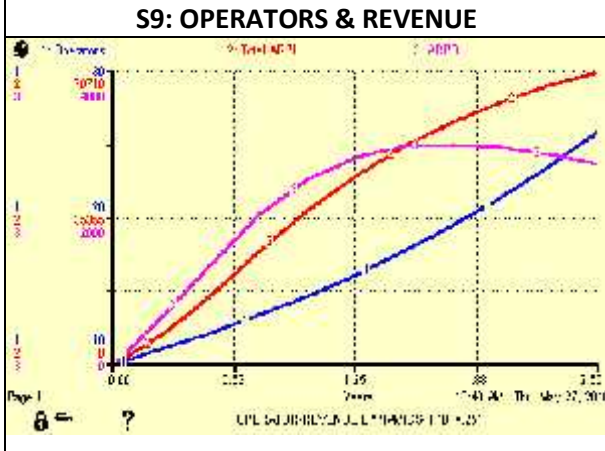
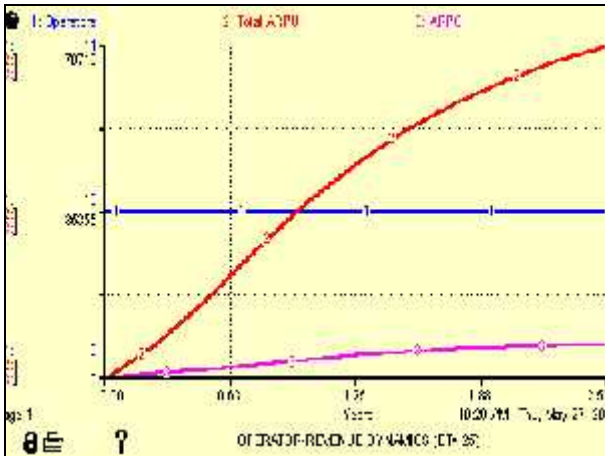

Figure-8 for Graph S6, S7, S8 and S9

Keeping the number of operators constant in the Infrastructure sector, Graph S9 projects increasing revenue per operator keeping operators number unchanged, but, considering the merit of maturing competition and the shift of margin due to new entrants (projected to grow @50% per annum from the current volume of 10operators/circle), the revenue fall is only at arm's length distance most probably starting by year 2012 itself, despite the fact that there may also be some sort of industrial consolidation (Exit ratio pegged @10%) (Graph S10).





Simulation 5: Research and Development Dynamics

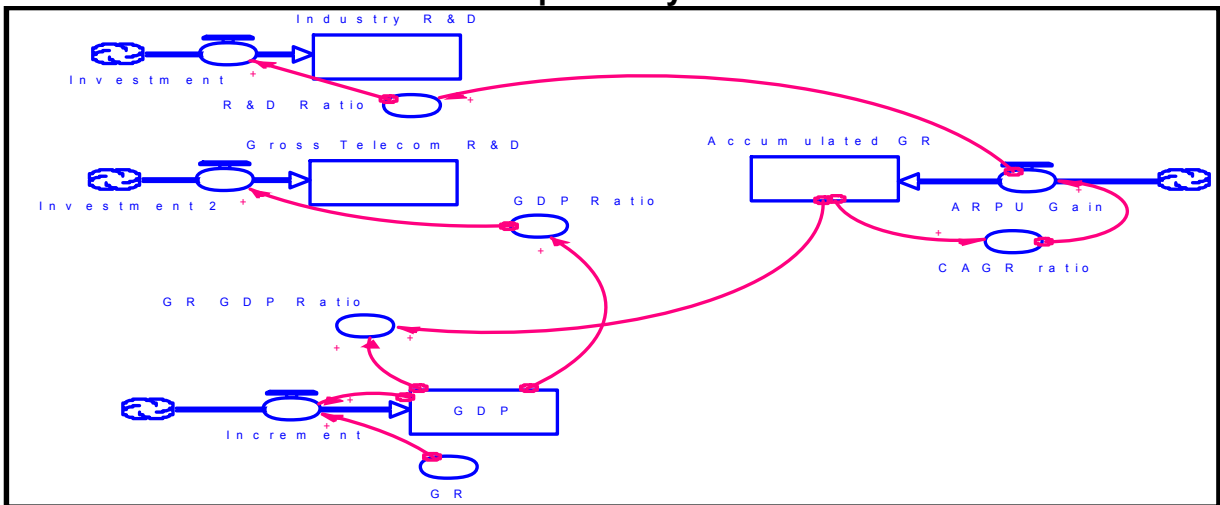

Figure-9 for Graph S11

Technology and Equipment R&D is fundamental both for the manufacture of mobile handsets and the service providers to garner industrial long-term success: R&D fuels infrastructure up gradation, new products, market share, high margins and rates of growth. The telecom R&D sector is equally interesting (Graph S11). In the composite graph depicting Industrial Gross Revenue, GDP growth and R&D as an integrative dynamics, we can see the R&D growth for product and equipment innovation which is projected to be doubled to 30% from current 15% (using indicative STEP function) by the year 2012 on account of improved competitiveness supported by the revenue contribution (projected to grow to \$54 billion from current \$43 billion by 2012). It also signifies why telecom manufacturing and Technology companies in India have started recognizing that when the cycle turns upward, companies with upgraded technologies and innovations coming out of the development pipeline are better positioned to profit than those companies that slashed R&D.

In case of Gross telecom R&D, shown here as a GDP derivative variable (estimated @1% rate), a net gain in GDP growth would further push the gross R&D slope upward under a positive feedback mechanism which would also translate into leveraging the domestic telecom market pull and firms firms that cut R&D too much are in danger of saving today to the detriment of growth tomorrow.

2.7. 3G Impact dynamics of Telecom Diffusion in India:

It is estimated that as a result of 3G introductions in the telecom sector, the number of 3G subscribers in the country will grow from existing 8 million users at a CAGR of around 130% to around 60 Million during 2010 to 2013. This trend data, once modeled in our base model (Graph S12), gives a sudden push at time point 3, however, in reality the trend of subscribers growth is expected to be more gradual spanning over three years during 2010-2013. Nevertheless, the quantum of 3G impact is also reflected in revenue gain (Graph S13-A*) and by 2013, 3G service revenues are expected to generate \$15.8 billion, accounting for a share of 46% in overall wireless service revenue. Also, this would invariably translate into ARPU of \$250 per user for 3G operators and effectively create a reversal impact over the declining APRU (estimated going down by declining rate of 30% / annum) slope for Indian mobile industry during 2010-2013 period (Graph S13-B*). This will be in a historical contrast to the declining trend of ARPU even though accumulated revenue will always be on rise. The projection done here is in congruence with various official estimates that the 3G ARPU is not expected to rise significantly in the initial years rather would be more visible in relatively long term. For instance, the overall ARPU has improved by 13% in countries

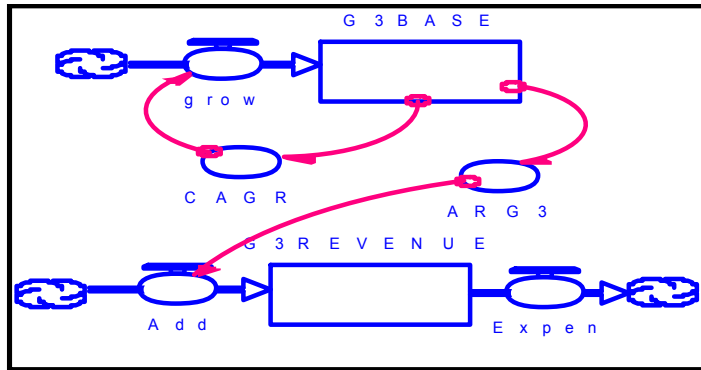
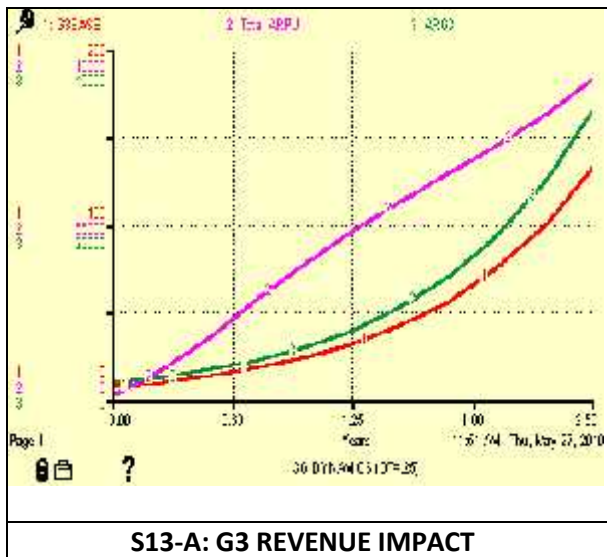
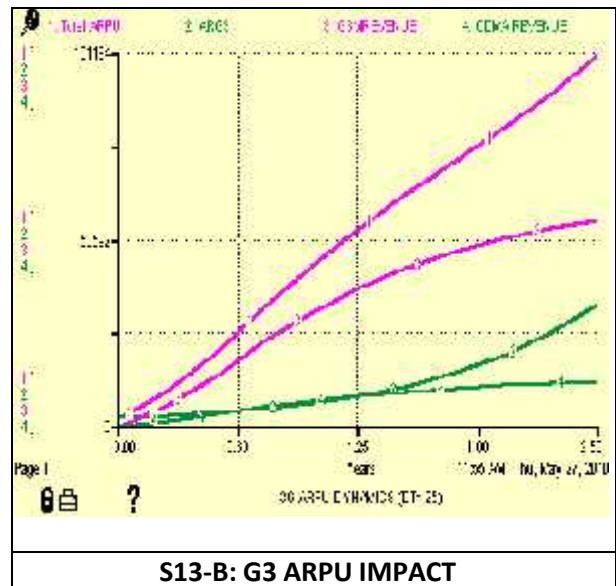

Figure 10: G3 Dynamics Diagram

like South Korea and Italy, whereas UK had a 15% increases. Further on account of rapid growth of 3G subscribers and resultant higher revenue realization as compared to GSM or CDMA subscribers, 3G revenue might be approaching to intersect the GSM revenue in long term beyond 2020 by a narrow margin (Graph S13-C*). Not to mention that, 3G revenue is projected to surpass the CDMA revenue curve much before that.



S13-A: G3 REVENUE IMPACT



S13-B: G3 ARPU IMPACT

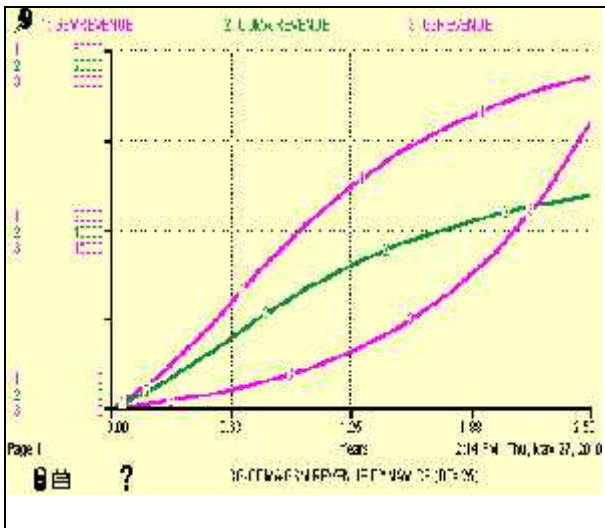

S13-C: G3-GSM REVENUE DYNAMICS

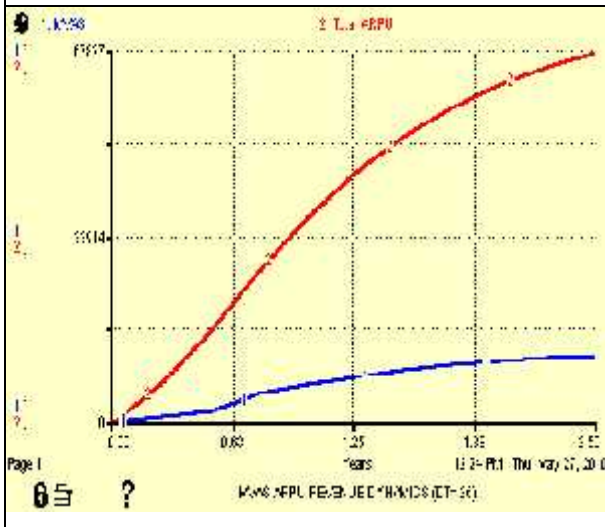

S13-D: MVAS IMPACT

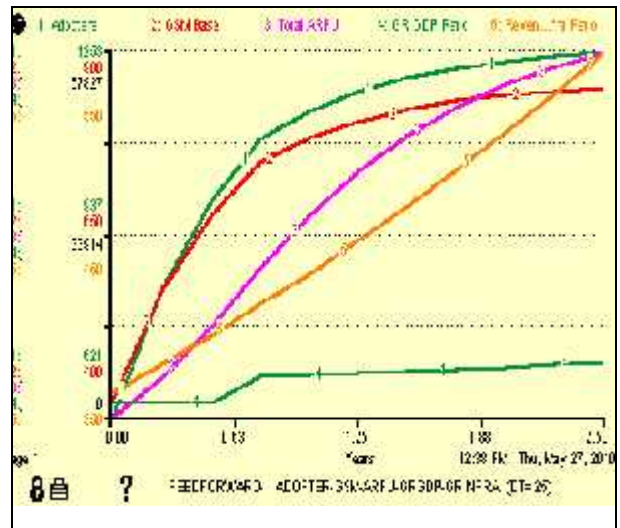

S14-A: FEEDFORWARD-I DYNAMICS

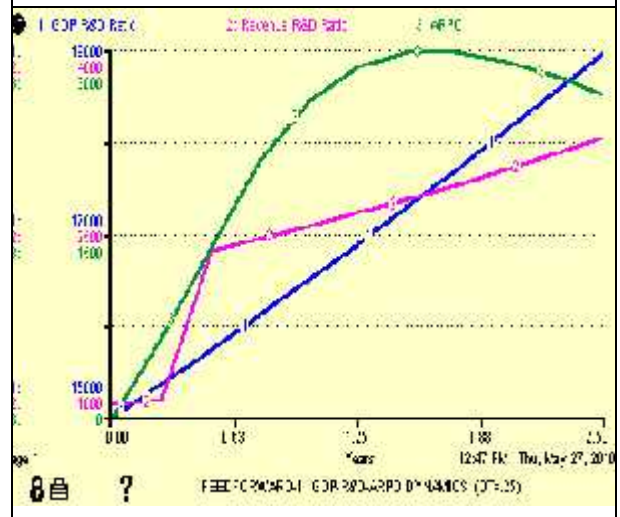

S14-B: FEEDFORWARD-II DYNAMICS

Hence, the impact of 3G on industry is projected to be strongly positive, more so, as users gain a richer and more engaging service experience, prompting them to use new multimedia services and use them for longer periods of time. However, the overall impact on ARPU will be determined by pricing/bundling strategies that operators adopt. In some markets, where 3G services have already been provided, operators have adopted a penetration pricing strategy, aimed at building a strong base of 3G users by pricing 3G services attractively

2.8. Multimedia (Mobile) Value Added Service Impact of 3G:

As we have seen in the earlier simulations that falling ARPU is the foremost concern of India telecom operators, as a result, telecom operators need to focus more on data and value added services to meet the revenue deficit caused by fall in revenue by their core business i.e. Voice. World over the higher percentage of Data revenue balances the fall in ARPU and seeing the trend, India offers enormous opportunity (Table 5).

	Voice	Data
International Markets	80%	20%
India	92%	8%

Table 5: International Market Vs Indian Market

At present in India, the share of MVAS is 10% in total operators revenue, but it is expected to go 18% by 2013 (S13-D*) with 60 million users expected to be using 3G services (i.e. 10% of existing number of adopters) once 3G comes in to the picture and we can expect this segment to become bigger and play a very important role (in terms of total revenue generation, it is poised to touch approx US\$ 2 billion by 2013).(Graph 13-D)

(Note: *In the projection graphs from 13A-13D, certain projection have been deliberately done using STEP function to point out their quantum impact over the system and highlight the magnitude of difference with respect to the impact done by other related variables knowing that the real impact would be more gradual and progressive in nature.)

2.9. Feed Forward- Feedback Dynamics of Telecom Diffusion

Feed Forward (Contagion Effect):

Integrative model stands to highlight the marvel of contagion effect which signifies that any change occurring at any segregated module of a total system model gradually spills over other connected sectors and therefore, brings about proportionate systemic changes. A metaphor of this can normally be seen now days in the global stock market behaviour. We also see strikingly similar flow of signals or dynamic pulses spanning over our innovation model. Simulated separately, we see such feed forward contagion effect clearly visible through the first connecting feed forward loops of Adopters, GSM Base, ARPU, Gross Revenue-GDP Ratio, GR-Infrastructure Ratio (S14-A) and the second loop of GDP-R&D, GR-R&D and ARPO all together generating an orchestrated diffusion mechanism. It further demonstrates the power of systemic analysis in policy making in order to improve the economic landscape of a nation holistically.

2.10. Feedback Dynamics (S15-S18): GDP-Tele-density Ratio-Rate of Adoption-Average Revenue Per User (STEP Year: 2010-2013)-

Developing an SD model of system behavior consists essentially of identifying the feedback loop structure of the system and validating it by comparing the model behavior to actual observed behavior. Apart from several underlying feedback effects discussed earlier, it is found that extraneously, mobile telephony and growth in Gross Domestic Product (GDP) have strong positive correlation. It is estimated that, for every one percent increase in tele- density, the GDP growth rate goes up to 0.3 to 0.6 percent or vice versa, it is estimated that every single percent increase in GDP in India results into effective increment of the national mobile tele-density by 3 percent (S15, Ratio 1:3). We

have been able to simulate this positive feedback effect first at the national level taking into consideration the annual growth of Indian population and then, estimated that the mobile penetration in India would reach the level at 1053.17 million subscribers by 2015 which is approx 85% of market penetration when population is projected to grow at CAGR 1.3% per annum which is demonstrated in Graph S16 applying STEP time function. Other government sources also suggest that there is direct relationship between tele-density, GDP and economic growth. The Government of India also reorganizes that provision of world class telecommunications infrastructure and information is key to rapid economic and social development of the Country. According to our estimate, though, that the feedback effect will not stop here; rather, it would spread over to the revenue sector (S17 & S18) and result into revenue of \$ 56,546.36 billion by the year 2015 divided proportionately between CDMA and GSM sector.

Suming up, seeing the simulation results, we can say that the systems dynamics based integrative modeling approach has yielded valuable insights into the mechanics of innovation diffusion of Indian telecom market. Moreover, these simulation models can serve as decision support tools for diffusion planning purposes since they also educate us about the dynamics of diffusion under a macro perspective. We, however, view the model presented here as a first step towards a more comprehensive model of innovation diffusion for the Indian telecom industry.

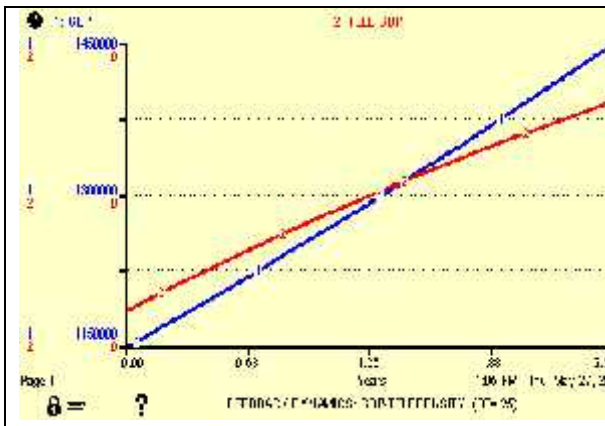

S15: FEEDBACK DYNAMICS (GDP-TELEDENSITY)

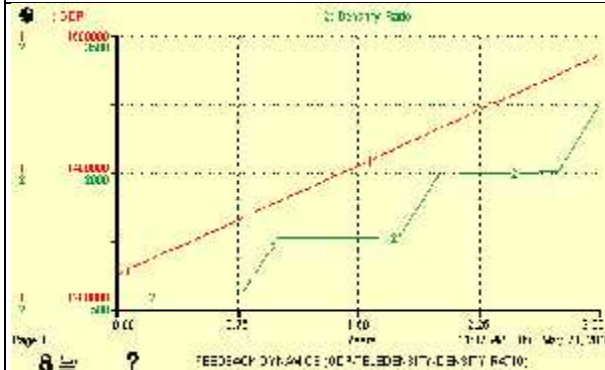

S16: FEEDBACK (GDP-DENSITY RATIO)

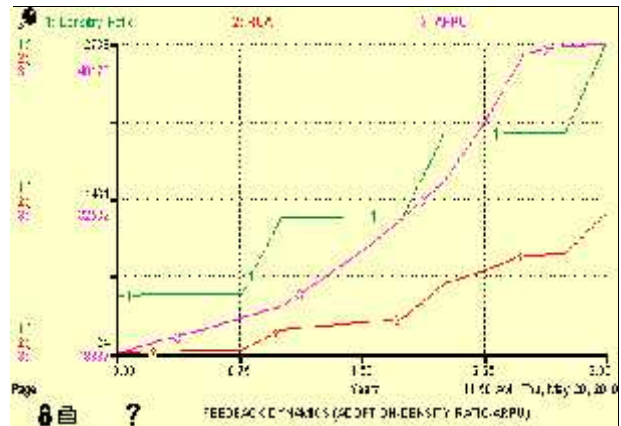

S17: FEEDBACK (DENSITY-ROA-APRU)

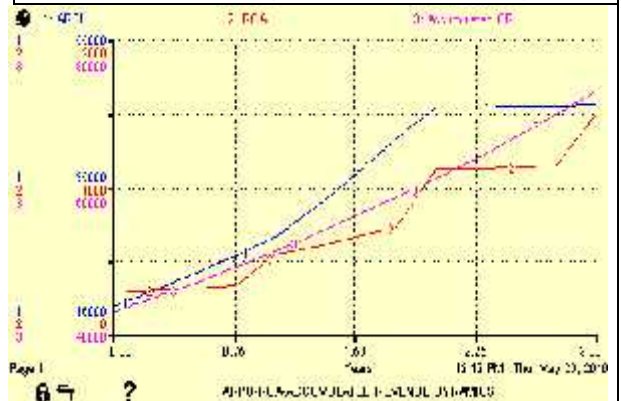

S18: FEEDBACK (APRU-ROA-TOTAL REVENUE)

2.11. Future Projections:

Based on the base model simulation, following is a consolidated projection (split for the Year 2015 & 2020) for identified system variables understood to be critical decision parameters in view of their impact and representation of the holistic telecom dynamics:

Table 6: Simulation Forecast Values

SD-SIMULATION FORECAST 2015-2020 (in millions, DT .25= 1 Year on X-axis)			
	VARIABLES	YEAR 2015	YEAR 2020
	POPULATION	1246.15	1342.31
	ADOPTERS	1,053.17	1,237.84
	3GBASE	32.67	133.43
	GSM	716.16	822.41
	CDMA	337.01	387.02
REVENUE	3G	6744.52	26120.28
	GSM	38720.38	53518.52
	CDMA	8292.17	11370.56
	Total ARPU (Revenue)	55180.43	98246.22
	Total ACPU (Cost)	27382.43	32183.92
INVESTMENT	INFRA	107,494.18	138,101.95
	TEL R&D	31,207.16	53,004.86
	INDUSTRY R&D	6,952.58	10,599.19

Section-III: Application of Neural Network in Capturing Innovation Dynamics in Telecom

It is evident in the above exploration of system model that there are still a number of interactions of the diffusion model for which we don't have explicit relative formulation on account of unavailability of required data or information.

To address this problem, we can invoke the pattern learning and a quick response capability of artificial neural network (Satsangi 2002). In case of imprecisely formulated problem, neural net can extract information from the given set of input-output data pattern and through repeated learning of back propagation; the network tries to adjust the weights to minimize the error. In this way, the network is basically discovering patterns in the given data series and moving towards the optimum representation of the problem situation.

For our study, architect of Multilayer perceptrons (MLPs) of neural network has been used to train the neural net with the system dynamics simulation results generated in the previous exercise of modeling. A visual schema of neural architect can be seen below in Figure 5. The decision panel in Neurosolution software has been used to specify the parameters of neural training and for its cross validation. The number of PEs and learning parameters can be seen in the corresponding columns of table. The learning rule and nonlinearity are selected from a list of options contained within the

software environment. Note that, for our problem, the selected output is “Number of Adopters’ tagged in the interfacing spreadsheet of neural environment as an output column whereas 10 input columns have been tagged as Infrastructure, GDP, Industrial R&D, Population, Profitability, ARPU, ACPU, CDM Revenue, GSM Revenue and Teledensity.

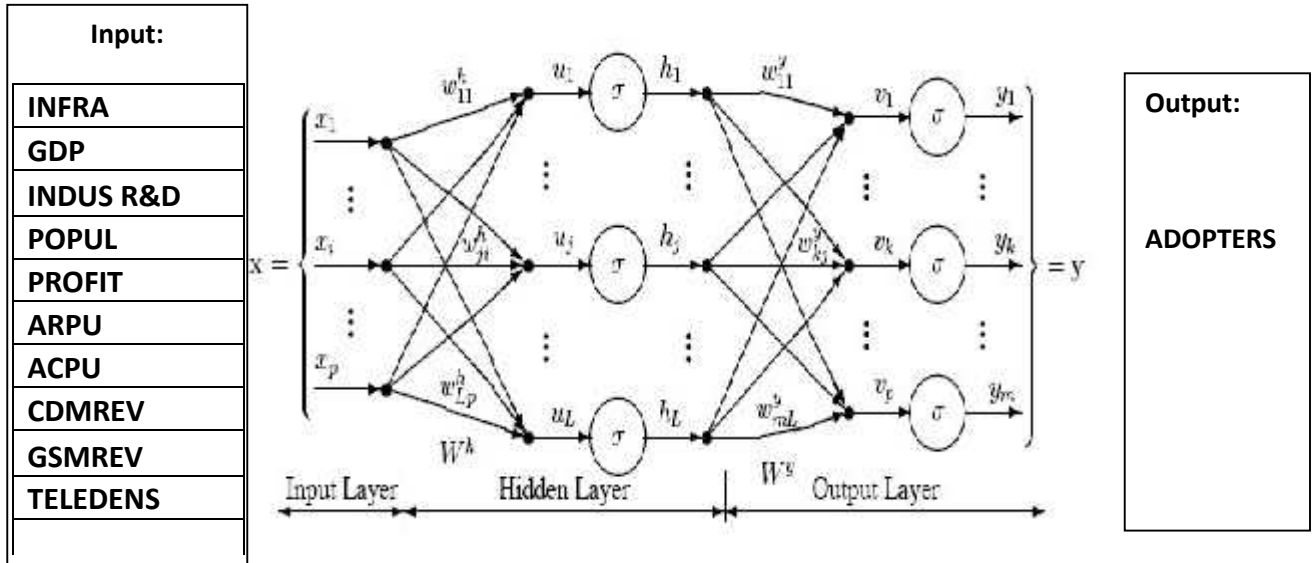
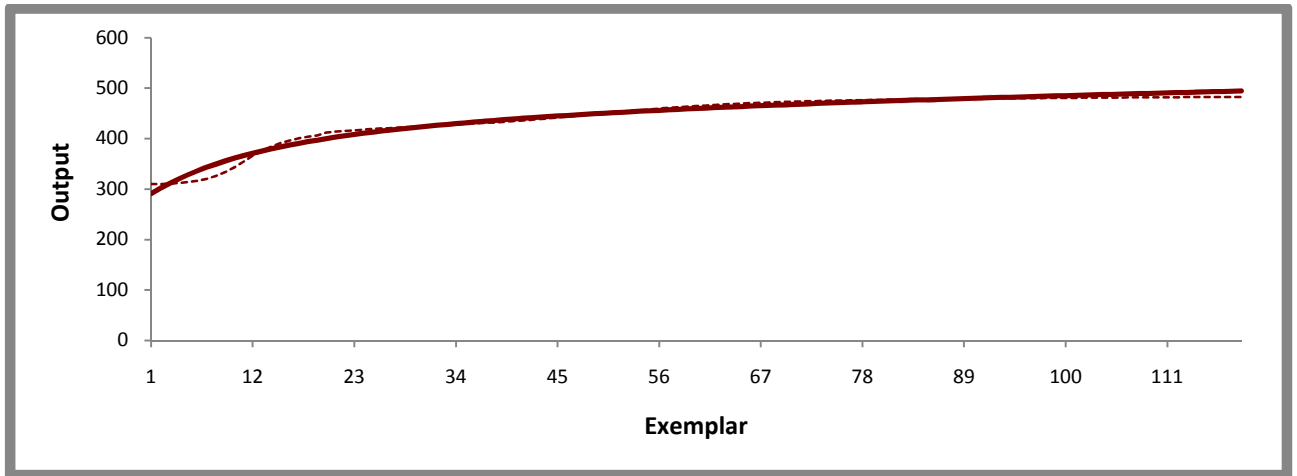

Figure 11: Neural Architect and Input-Output Variables

Neural training parameters:	
Input PE (Control Variables)	10
Output PE (Adopters)	01
Exemplar	120 Time Points
Hidden Layer	01
Processing Elements	04
Input Learning Rule: Momentum	(Default Value in Neurobuilder)
Step Size: 1.00	
Momentum:0.70	
Output Learning Rule: Momentum	(Default Value in neuro builder)
Step Size: 0.10	
Momentum: 0.70	
Epoch	1000
Minimum MSE Threshold	.01
Data Usage:	12 Channels, 1330 data elements, 1320 Used, 120 Samples

Learning from the fed data is the essence of neurocomputing . An MLP trained on the data generated through the SD modeling and the training results are shown below. The network is configured to automatically save the weights of the network when the error reaches a bottom. For the present set of training data, the average error (MSE) range diminishes at 0.000126158 after three runs,



<i>Best Networks</i>	<i>Training</i>	<i>Cross Validation</i>
Run #	2	3
Epoch #	1000	1000
Minimum MSE	0.000126158	0.009524197
Final MSE	0.000126158	0.009524197

Figure 12: Neural Production Plot with Error Values

One can see above in the production plot, the striking resemblance of actual network output with the desired output of ‘Adopters’ instilling a degree of validity about a successful neural training, however, one also needs to perform cross-validation test with classified set of data in order to satiate the training requirement. (see the results of training and validation above)

3.1 Sensitivity Application:

Sensitivity analysis is used to determine how “sensitive” a model is to changes in the value of the parameters of the model and to changes in the structure of the model. (Lucia Breierova et al. 2001). In this section, we focus on parameter sensitivity performed as a series of tests under neural network simulation capturing patterns to see how change in the input parameters causes a change in the dynamic behavior of the output stock of number of innovation adopters. By knowing how the model behavior responds to changes in input parameter values, neural network based sensitivity analysis appears to be a useful tool in model building as well as in model evaluation and simplification. (Hunter et al. 2000).

As we saw in the previous section after successful neural training and validation, we can now perform sensitivity analysis on a trained network to measure the dynamic and symbiotic interactions existing between system variables and to check for the influence of parameters for which no direct empirical estimate was available. From the perspective of system dynamics, it can help in recognizing the causal relationship between desirable state variable (Output) and corresponding decision variables (Input)

in order to generate insight about their mutual interplay and influential sensitivities. We can see in the table below the sensitivities of some of the tested control variables viz. Infrastructure, GDP, R&D, Market Population and Tele-density with respect to cumulative number of adopters (see Table 7)

This insight is remarkably significant in estimating the impact of input variables over the desired output even when we don't have precise relational information. In the present case, higher values of selective inputs also emphasize their criticality and control impact over the selected output variable of 'number of adopters' for telecom innovation diffusion in India. In other word, we can infer that the more sensitive parameters have higher impact over the adoption process as compared to low sensitive parameters. This also opens up the possibility of improving the system model by discarding variables which stand insignificant to govern the output of the model.

**Sensitivity of Key decision Stock variables towards the number of Adopters:
Table 7: Sensitivity Results**

Base Model Factors	Sensitivity
INFRA	23.77370601
GDP	22.49498163
INDUSR&D	14.32566645
MKT. POPULATION	3.896070528
TELEDENS	17.43967239

(Appendix C: Experimental Neural Simulation Results and related Figures)

Applying neural architect in system modeling can thus help us in enriching our understanding to capture diffusion characteristics at a finer level of detail and make it more useful for planning and decision making purposes. One can also perform scenario projections based on sensitivity results and develop simulating topologies with multiple controllers. It can facilitate creating a scenario based on a number of assumptions and test the sensitivity of change events over related variables of problem under investigation. From our analysis, we can treat the sensitivity values of input variables as their respective magnitude of influence that they exert over the output variable i.e. Adopters in our case. In fact, the sensitivity value is a coefficient describing the relation of its movement with that of the input variable and can be treated as a value of correlated relative volatility. In this way, the sensitivity coefficient is a key parameter in measuring the part of the 'output' structural variance that cannot be mitigated by any means because it is correlated with the values of other variables in the whole system or in the portfolio of variables. So, by having arrived at the above values, one can easily check for the change a single percentile in inputs brings about over the output.

3.2. Scenario Analysis:

In our base model, we have assumed that one subscriber would be using one mobile service at a time; however, at some stage of market growth, we need to pragmatically include a multi service usage situation to the model.

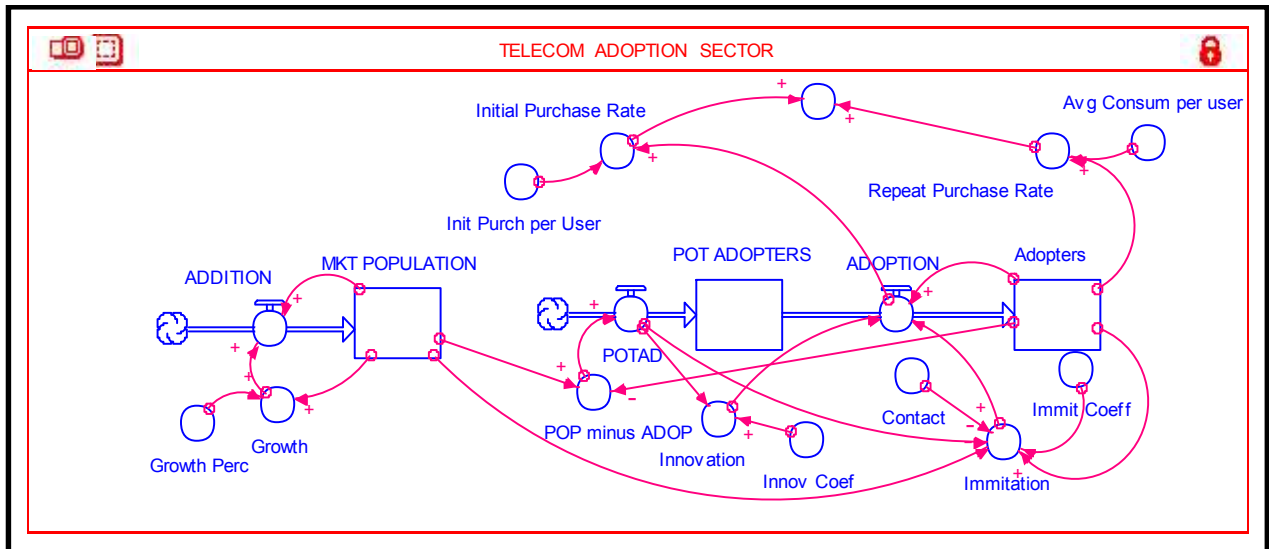

Figure 13: Scenario Diagram

Therefore, by applying scenario in the projection model with respect to repeat purchase behavior (average consumption of services being > 1) noticeable in many circles in Indian telecom sector (e.g. in circles like Delhi, the penetration has gone beyond 150 percent), we may find that the number of actual users and thereby total quantum of sales generated (TSR) would be far more than the total number of subscribers based on earlier projection (see Graph 19). In our base model, if we assume that even only 20 percent of 85 percent (approx 1000 million) of Indian population above poverty line go for repeat purchase (which appears to be quite pragmatic), the total number of actual user would move to 1412 million by Year 2020 from the subscriber's volume of 1096 million, giving ample indication and incentive to telecom operators to intensify their marketing campaign in order to capture and exploit the inherent potential of the Indian market (or at least, in some profitable segments).

Scenario system equations:

$$\text{Initial_Purchase_Rate (IPR)} = \text{ADOPTION} * \text{Init_Purch_per_User}$$

$$\text{Init_Purch_per_User (IPPU)} = 1$$

$$\text{Avg_Consum_per_user (ACPU)} = 1.2$$

$$\text{Repeat_Purchase_Rate (RPR)} = \text{Adopters} * \text{Avg_Consum_per_user}$$

$$\text{TOTAL_SALES_RATE (TSR)} = \text{Initial_Purchase_Rate} + \text{Repeat_Purchase_Rate}$$



Graph S 19: Multi usage Scenario Dynamics

3.3. Conclusion

This research has attempted to propose a new modeling approach for the investigation of diffusion of mobile telecommunications services in Indian telecom market. It can be found that the proposed model which incorporates the integrative modular framework of generating causal dynamics prevalent in the telecom sector also successfully acquires the capability of short-mid-long term forecasting. It, to a substantial extent, effectively discards the notion that holistic modeling brings into 'coarseness' in the modeling and therefore cannot be applied for future projections. It has been proved that if the causality of model variables can be founded upon a robust model with the support of conceptual and quantitative information, one can succeed to capture the dynamics of any system in a comprehensive way.

As can be seen here that the modeling was primarily first done based on the conceptual insight drawn through an extensive literature survey and thereafter it was put to further refinement, customization and validation taking a case study of Indian telecom market. The novelty of this kind of modeling approach is that, the generic framework used here suits to adapt to any socio-economic situation and be able to incorporate, substitute or modify any number of system variables or values. Furthermore, a new neural application was developed aimed to measure the non-parameterized sensitivity amongst the identified system variables. The interface between the system dynamics modeling and neural network offers novelties revealing the possibilities of real time up dation and up gradation of a dynamic system and to define and demonstrate the interactive impact even in imprecisely formulated problem situation.

In nut shell, concerning the methodological approach proposed and discussed in this paper, we can say that the traditional Bass model of innovation can surely be comprehensively extended and expanded in order to encompass quite a few numbers of system variables in order to provide a better fit for holistic demonstration of innovation diffusion behavior and to consequently acquire insight for the mutual and ever

propagating interactions taking place in the system. It would also assist in making more pragmatic assumptions and parameterization for more similar system conditions. Also when direct causal parameterization is not possible due to lack of data, an alternative may also be developed in the form of neural network to capture the unknown knowns and perform sensitive analysis and scenario projections to predict the outcome of inherent dynamics or variations.

In the end, we can sum up the core attributes of present study by highlighting that the undertaken research has succeeded in -

- Building a robust integrative system model of innovation diffusion in a specific context of Indian Telecom Sector.
- Capturing the 'whole' along with the 'parts' dynamics of innovation diffusion mechanism.
- Validating and confirming the consistency of the model using historical telecom trend.
- Identifying some critical incumbent Feedback and Feed forward loops defining the underlying trends and dynamics of diffusion.
- Developing a forecast model based on real data sourced in from public domain (this has greatly overcome the limitation of opinion based stock-flow models)
- Creating Scenarios and analyzing the future impact.
- Combining the innovative properties of system dynamics with that of neural network modeling and simulation
- Charting out a future course of applied researches in the field of system modeling

3.4. Future research direction:

One very useful extension of the present research would be integrating 'Event' in the model. This would greatly facilitate in coping with abrupt uncertainties though calculated calibration and modification in the base model. It is known that lack of foresight in projective studies can create uncontrollable ripples in an system and makes it susceptible. The approach used here has captured the literature and historical data and derived intelligence from the past and projected known patterns. But in the absence of a history of calendarized events, the robustness and the performance would be compromised and moreover, analysis provided by this model is more retrospective with limited projective ability, while dynamic investigation of a system requires prospective analysis of the events-looking at the future, with the capability of running "what-if" scenarios for different combinations of future events.

References:

1. A. Borshchev and A. Filippov. From System Dynamics and Discrete Event to Practical Agent Based Modeling: Reasons, Techniques, Tools. The 22nd International Conference of the System Dynamics Society, July 25 - 29, 2004, Oxford, England
2. Ayers, J.B. (2002) 'A primer on supply chain management', (p.5) pp.5–17, and 'Supply chain strategies', pp.105–115, *Making Supply Chain Management Work, Design, Implementation, Partnerships, Technology, and Profits*, J.B. Ayers (Ed.), Boca Raton, CRC Press.
3. Alfonso T. Sarmiento, Luis Rabelo, Reinaldo Moraga , Albert Jones, A Parameter Estimation Method to Minimize Instabilities in System Dynamic Models
4. Anderson D, Lee H (1999) Synchronized Supply Chain: the New Frontier. ASCET: Achieve Supply Chain Excellence through Technology
5. Andersen ES (1996) From static structures to dynamics: specialisation and innovative linkages. In: DeBresson C (ed) Economic interdependence and innovative activity: an input–output analysis. Elgar, Cheltenham
6. Apostolos N. Giovanis · Christos H. Skiadas, A new modeling approach investigating the diffusion speed of mobile telecommunication services in EU-15, Springer Science+Business Media B.V. 2006
7. Andreas Wanknerl, Guy F. DiCicco, Andrew T. Burch, Erik L. Charpentier, Aohan Chen, Market-Driven Innovation, *Business of Science and Technology Initiative, Cornell University, Ithaca, NY*
8. Andrew Hunter, Lee Kennedy, Jenny Henry and Ian Ferguson, Application of neural networks and sensitivity analysis to improved prediction of trauma survival Computer Methods and Programs in Biomedicine, Volume 62, Issue 1, May 2000, Pages 11-19
9. Byungryoung Kang Hojoong Kim, Chimoon Han and Chuhwan Yim, A demand-based model for forecasting innovation diffusion Electronics and Telecommunications Research Institute, 161 Kajong-Dong, Yusong-Gu, Taejon, 305-350, Korea
10. Bretschneider. S. I.. and Mahajan, V., Adaptive Technological Substitution Models, *Technol. Forecast. Soc. Change*, 18, 129-139 (1980).
11. Barbara Wejnert, Integrating models of diffusion of innovations: A Conceptual Framework, *Annual Review of Sociology* Vol. 28: 297-326, 2002.
12. Baptista R (1999) The diffusion of process innovations: a selective survey, *International Journal of the Economics of Business* 6(1):107-130.
13. Bass F (1980) The relationship between diffusion rates, experience curves and demand elasticities for consumer durable technological innovations, *Journal of Business* 53: 551-567.
14. Bass, Frank M., Krishnan V. Trichy and Dipak C. Jain (1994), "Why the Bass model fits without decision variables", *Marketing Science*, 13 (3), 203-223.
15. Burns JR, Ulgen O. Removing information delays from supply chains: the implications, Internet reference: http://www.pmc corp.com/pub_simulation.shtm www.pmc corp.com/pub_simulation.shtm, 2004
16. Carlsson Bo, Staffan Jacobsson, Magnus Holménb, Annika Rickne , Innovation systems: analytical and methodological issues, Elsevier, Research Policy 31 (2002) 233–245
17. Cheryl J. Kuberka, Donald E. Olson, *Business of Science and Technology Initiative, Cornell University, Ithaca, NY*
18. Carter AP (1990) Upstream and downstream benefits of innovation. *Econ Syst Res* 2:241–257
19. Cachon G, Zipkin P (1999) Competitive and Cooperative Inventory Policies in a Two Stage Supply Chain. *Management Science*. 45(7): 936–953
20. C.J. Easingwood, V. Mahajan and E. Muller. A nonsymmetric responding logistic model for technological substitution, *Technol. Forecast. Soc. Change* 20, 199-213 (1981).
21. C. J. Easingwood, V. Mahajan and E. Muller. A nonuniform influence innovation diffusion model of new product acceptance. *Market. Sei.* 2, 273-295 (1983).
22. Christopher, M. (1992), *Logistics and Suppl). Chain Management*. London: Pitman Publishing.
23. Chen Y-T, Jeng B. (2004). Policy design by fitting desired behavior pattern for system dynamic models. *Proceedings of the 2004 International System Dynamics Conference*, Oxford, England.
24. Christopher J. Easingwood, Vijay Mahajan, Eitan Muller, Nonuniform Influence Innovation diffusion Model of New Product Acceptance, *Marketing Science*, Vol. 2, No. 3, Summer 1983, pp. 273-295

25. Caputo AC, Cucchiella F, Fratocchi L, Pelagagge PM and Scacchia FA (2002) Methodological framework for innovation transfer to SMEs, *Industrial Management & Data Systems* 102(5): 271-283.
26. Chatterjee R and Eliashberg J (1990) The innovation diffusion process in a heterogeneous population: A micromodeling approach, *Management Science* 36(9): 1057-1079.
27. Checkland, P., *Systems Thinking, Systems Practice*, John Wiley & Sons, Chichester, 1990.
28. Christopher, M., Lee, H.L., 2004. Mitigating supply chain risk through improved confidence. *International Journal of Physical Distribution & Logistics Management* 34 (5), 388–396.
29. Chandrasekaran, D. and G.J. Tellis. 2008. *A critical review of marketing research on diffusion of new products*. Marshall research paper series working paper MKT 01-08. Available online at: http://papers.ssrn.com/sol3/papers.cfm?abstract_id=969775.
30. David Corkindale The University of South Australia, and Beng Chea Institute for Infocomm Research (I2R), Singapore Supply-side factors' effect on the diffusion of an innovation across ASEAN Countries
31. D. Horsky. A diffusion model incorporating product benefits, price, income and information. *Market. Sci.* 9, 342-365(1990).
32. Database and Expert Systems Applications, DEXA'04, Innovation Diffusion: Predicting Success of System Development, Spainaragoza, ISBN: 0-7695-2195-9, Spain , 2003
33. Dekimpe, Marnik G., Philip M. Parker and Miklos Sarvary (1998), "Staged estimation of international diffusion models: An application to global cellular telephone adoption", *Technological Forecasting and Social Change*, 57 (1), 105-132.
34. David F. Midgley , The nature of communication network between organizations involved in the diffusion of technological innovations, *Advances in Consumer Research* Volume 18, 1991 Pages 635-643
35. Dongping Huang, Hessam Sarjoughian, Simulation of Semiconductor Manufacturing Supply-Chain Systems , Special issue of IEEE Trans. On semiconductor manufacturing.
36. Deepa Chandrasekhran and Gerard J Tellis, Critical review of Marketing research on diffusion of New products, *Review of Marketing research*, pp. 39-80, 2007 Marshall School of Business Working Paper No. MKT 01-08
37. Enrico Santarelli, The Diffusion of E-commerce at the Firm Level: Theoretical Implications and Empirical Evidence° by Università di Bologna – Dipartimento di Scienze Economiche, Strada Maggiore, 45; I-40125 BOLOGNA; ITALY
38. Erik Arnold and Martin Bell, *Some New Ideas About Research for Development*, in Danish Ministry of Foreign Affairs: Partnership at the Leading Edge: A Danish Vision for Knowledge, Research and Development (April 2001).
39. E. Mansfield. Technological change and the rate of imitation, *Econometrica* 29, 741-766 (1961).A. W. Blackman Jr. A mathematical model for trend forecast. *Technol. Forecast. Soc. Change* 3, 441-445 (1972).
40. Forrester, J. W., 1961, *Industrial Dynamics*, MIT Press, Cambridge, MA
41. Frank H. Maier New product diffusion models in innovation management - a system dynamics perspective, *Industrieseminar der Universität Mannheim*, D-68131 Mannheim, Germany
42. F. M. Bass. A new product growth model for consumer durables. *Mngmnt Sci.* 15, 215-227 (1969).
43. Flood, R.L. and Jackson, M.C., *Creative Problem Solving: Total Systems Intervention*, John Wiley & Sons, Chichester, 1993.
44. Fourt, L.A. and Woodlock, J. W. (1960), Early prediction of market success for grocery products, *Journal of Marketing*, Vol. 25, October, pp. 31-38.
45. Frank H. Maier, New product diffusion models in innovation, management- a system dynamics perspective, *MaieraSystem Dynamics Review* Volume 14 Number 4 Winter 1998
46. Freeman, 1988. Freeman, C., 1988. Japan: a new national system of innovation? In: Dosi, G., et al. (Eds.), *Technical Change and Economic Theory*. Pinter Publishers, United Kingdom, pp. 330–348.
47. Frances S. Berry, Expanding our Models of Innovation and Diffusion for Multi-level Governance Research, *Frank Sherwood Professor of Public Administration* Freeman, C., *The economics of Industrial Innovation*, Penguin, Harmondsworth, 1974.

48. Gek Woo Tan Rachel Yang, Science Drive 2 University of California at Los Angeles, Los Angeles, California 90024 October 19, 2001
49. Geroski, P.A. 2000. "Models of technology diffusion". *Research Policy*, 29, 603-625.
50. Graziella C. Bonadia, Giovanni M. de Holanda, Ricardo B. Martins, A System Dynamics Analysis of ICTs' Diffusion in the Brazilian Market, Telecom R&D Center, Campinas – SP Brazil
51. Giddens, A. (1990) *The Consequences of Modernity*. Stanford: Stanford University Press, Source: Global Wind Energy Council 2009.
52. Griliches Z (1980) Hybrid corn revisited: A reply, *Econometrica* 48(6): 1463-1465.
53. Guido Lorenzoni, A Theory of Demand Shocks, *American Economic Review*, 99(5): 2050
54. Hani I. Mesak Incorporating price, advertising and distribution in diffusion models of innovation: Some theoretical and empirical results, Louisiana Tech University, LA 71272-0046, U.S.A.
55. Hans-Dietrich Haasis, Herbert Kopfer and Jörn Schönberger, Operations Research Proceedings 2005 Selected Papers of the Annual International Conference of the German Operations Research Society (GOR), Bremen, September 7–9, 2005
56. Harald Gruber, *Effect of competition and innovation: Competition and innovation^{*1}*: The diffusion of mobile telecommunications in Central and Eastern Europe European Investment Bank, 100 Boulevard Konrad Adenauer, L-2950 Luxembourg, Luxembourg 2001.
57. Ho, T.-H., S. Savin, C. Terwiesch. 2001. Managing demand and sales dynamics in new product diffusion under supply constraint. Working paper, The Wharton School, University of Pennsylvania, Philadelphia, PA. (<http://hops.wharton.upenn.edu/people/faculty/ho.html>).
58. Hannan T and McDowell J (1984) The determinants of technology adoption: the case of the banking firm, *Rand Journal of Economics* 15(3): 328-335.
59. Huang, Z., Cárdenas, A. F., "Extracting Hot Events From New Feeds, Visualization and Insights," 2009 *Distributed Multimedia Systems Conference*, San Francisco, California, September 10-12, 2009
60. Jeremy Howells, Intermediation and the role of intermediaries in innovation, *Research Policy* 35 (2006) 715–728, *ESRC Centre for Research in Innovation and Competition (CRIC), Institute of Innovation Research, University of Manchester, Harold Hankins Building, Booth Street West, Manchester M13 9QH, UK*
61. James Perry and Kenneth L. Kramemer, Innovation Attributes, Policy Intervention, and the Diffusion of Computer Applications Among Local Governments, *Policy Sciences* 9 (1978), pp. 179-205_9 Elsevier Scientific Publishing Company
62. Johnson, S. 2001. *Emergence: The connected lives of ants, brains, cities, and software*. New York: Scribner.
63. J. C. Fisher and R. H. Pry. A simple substitution model of technological change. *Technol. Forecast. Soc. Change* 3,75-88 (1971).
64. Jain, Dipak, Vijay Mahajan, and Eitan Muller. (1991). "Innovation Diffusion in the Presence of Supply Restrictions," *Marketing Science*, 10(1), 83–90.
65. J. A. Norton and F. M. Bass. A diffusion theory of adoption and substitution for successive generations of high technology products. *Mngmnt Sei.* 33, 1069-1086 (1987).
66. Jeng & Chen, Patent 2: Neural network representation for system dynamics models and its applications, Intellectual property solutions, Alexandria, USA
67. John Sterman, *Business Dynamics: Systems Thinking and Modeling for a Complex World*, Irwin/McGraw-Hill, 2000
68. J. A. Sharp. An interpretation of non-symmetric responding logistic model in term of price and experience effects. *J.Forecasting* 3, 453-456 (1984).
69. J. Ashayeri, L. Lemmes., Economic Value added of supply chain demand planning: A system dynamics simulation, Center for economic research, The Netherlands
70. James M. Lyneis, A Dynamic Model of Technology Diffusion, Pugh-Roberts Associates
71. J. Janssen, C. H. Skiadas, & C. Zopounidis (eds.), *Advances in stochastic modelling and data analysis*. Dordrecht: Kluwer Academic Publishers.
72. JPC Kleijnen and MT Smits, Performance metrics in Supply chain management, *Journal of the Operations research Society* (2003), 507-514

73. Kumar and van Dissel, 1996 K. Kumar and H.G. van Dissel, Sustainable collaboration: managing conflict and cooperation in interorganizational systems, *MIS Quarterly* 20 (3) (1996), pp. 279–300. Full Text via CrossRef
74. Kang, B., H. Kim. A demand-based model for forecasting innovation diffusion, *Computers Industry Engineering*, 1996, 30(3): 487-499.
75. Karel O. Cool, Ingemar Dierickx and Gabriel Szulanski, Diffusion of Innovations within Organizations: Electronic Switching in the Bell System, 1971-1982 *Organization Science*, Vol. 8, No. 5 (Sep. - Oct., 1997), pp. 543-559
76. Karl M. Rich, Justin G. Gardner, David J. Spielman, _DRAFT PAPER, 13 NOVEMBER 2006 Innovation Africa Symposium, 21-23 November 2006 Kampala, Uganda ()
77. Lee H, So K, Tang C (2000) The Value of Information Sharing in a Two-Level Supply Chain Management Science. 46(5): 626–643
78. Lee HL. Ultimate enterprise value creation using demand-based management. Stanford Global Supply Chain, Management Forum, September, SGSCMF-W1-2001, 2001.
79. Lundvall, Innovation as an interactive process: from user-producer interaction to the national system of innovation. In: Dosi, G., et al. (Eds.), *Technical Change and Economic Theory*. Pinter Publishers, United Kingdom, pp. 349–369, 1988.
80. Lundvall, National Systems of Innovation. Towards a Theory of Innovation and Interactive Learning. Pinter Publishers, London, 1992.
81. La Londe, B. (2005), "Fiddling While Rome Burns?" *Supply Chain Management Review*, 9(7), 6.
82. L. Martin Cloutier, A System Dynamics Perspective on R&D Investments in Biotechnology, 10th annual meeting of the International Association for the Management of Technology, Lausanne, Switzerland, March 8-10 2001. Value Cycle and Innovation Management under Uncertainty:
83. Luis Rabelo, Chalermmon Lertpattarapong, Analysis of Supply chains using system dynamics, neural nets and Eigen values, Proceedings of the 2004 Winter Simulation Conference
84. Lynn, L.H., Reddy, N.M., Aram, J.D., 1996. Linking technology and institutions: the innovation community framework. *Research Policy* 25, 91–106.
85. Lucia Breierova, Mark Choudhari, An Introduction to Sensitivity Analysis, MIT System Dynamics in Education Project Under the Supervision of Dr. Jay W. Forrester, Vensim Examples, Massachusetts Institute of Technology, 2001
86. Mahajan, V., Muller, E., & Bass, F. M. (1990). New product diffusion models in marketing: A review and directions for research. *Journal of Marketing*, 54(1), 1–26.
87. Mahajan V., E. Muller and F. M. Bass. New product diffusion models in marketing: A review and directions for research. *J. Marketing* 54, 1-26 (1990).
88. Mahajan V. and E. Muller. Innovation diffusion in a borderless global market. *Technol. Forecast. Soc. Change* 45, 221-235 (1994).
89. Mahajan Vijay and Yorum Wind, Innovation Diffusion models of New product Acceptance, Working paper No. 85-038 Van den Bulte C & Stremersch S, 2004. Social contagion and income heterogeneity in new product diffusion: A meta-analytic test. *Marketing Science* 23 (4): 530-544
90. Mahajan Vijay, Eitan Muller and Frank Bass (1995), "Diffusion of New Products: Empirical Generalizations and Managerial Uses," *Marketing Science*, Special Issue on Empirical Generalization, 14, pp. 79-88.
91. M. N. Sharif and C. Kabir. A generalized model for forecasting technological substitution. *Technol. Forecast Soc. Change* 8, 353-364 (1976).
92. M. N. Sharif and M. N. Islam. The Weibull distribution as a general model for forecasting technological. *Technol. Forecast Soc. Change* 18, 247-256 (1980).
93. Max Åhman, Studies Government Policy and Environmental Innovation in the Automobile Sector in Japan Report No. 53, January 2004, Department of Environmental and Energy Systems
94. Morgan K (1997) The learning region: institutions, innovation and regional renewal. *Reg Stud* 31(5):491–503, *Computers and Operations Research* Volume 23, Issue 10, 1996.
95. Mansfield, E., J. Rapoport, J. Schnee, S. Wagner, and M. Hamburger. Research and innovation in the modern corporation: Conclusions. In *Corporate Strategy and Product Innovation*, ed. R. R. Rothberg. New York, London: The Free Press 1981.
96. Mohr, L.B. (1969) "Determinants of Innovation in Organizations", *The American Political Science Review*, 63, 1: 111-126

97. Moch, M.K. and Morse, E.V. (1977) "Size, Centralization and Organizational Adoption of Innovations", *American Sociological Review*, 42.5: 716-725
98. McEvily, B., Zaheer, A., 1999. Bridging ties: a source of firm heterogeneity in competitive capabilities. *Strategic Management Journal* 20, 1133–1156.
99. Milling, P. 1986a. Diffusions theories und Innovations management. In *Technologie- und Innovationsmanagement*, ed. E. Zahn. Berlin: Duncker & Humblot: 1986b. Decision support for marketing new products. In *System Dynamics: On the Move*, ed. J. Aracil, J. A. D. Machuca and M. Karsky. Seville, Spain: The System Dynamics Society: 787±793.
100. Milling (1986a; 1996) 290 *System Dynamics Review* Volume 14 Number 4 Winter 1998 , ĐĐĐ. 1987. Manufacturing's role in innovation diffusion and technological innovation. In *Proceedings of the 1987 International Conference of the System Dynamics Society*. Shanghai, China: The System Dynamics Society: 372±382.
101. Mitul Shah, Gilbert Kwame Owusu Mathias Kern George Anim-Ansah, Patent application title: Risk assessment forecasting in a supply chain, IPC8 Class: AG06F1730FI USPC , USA 2000.
102. Milne C (1997) *Telecom Reform: Principles, Policies and Regulatory Practices*. Denmark: DTU.
103. Malcolm Wright and Don Charlett, *New Product Diffusion Models in Marketing: An Assessment of Two Approaches*, *Marketing Bulletin*, 1995, 6, 32-41, Article 4, <http://marketing-bulletin.massey.ac.nz>
104. Mahler, A, Rogers, E M. 1999. The Diffusion of Interactive Communication Innovations and the Critical Mass: the Adoption of Telecommunications Services by German Banks. *Telecommunications Policy*, 23, 719-740.
105. My, K.B., Willinger, M., and Ziegelmeyer, A. (2006). Global versus local interaction in coordination games: An experimental investigation. *Journal of Evolutionary Economics*.
106. Nair, Harikesh, Pradeep Chintagunta, and Jean-Pierre Dubé (2004), "Empirical analysis of indirect network effects in the market for personal digital assistants", *Quantitative Marketing and Economics*, 2 (1), 23–58.
107. Nagurney, A., Cruz, J., Dong, J., Zhang, D., 2005. Supply chain networks, electronic commerce, and supply side and demand side risk. *European Journal of Operational Research* 164 (1)
108. Nelson, 1993. Nelson, R., 1993. *National Innovation Systems. A Comparative Analysis*. Oxford University Press, NY.
109. Peter J. Danaher, Bruce G.S. Hardie, William P. Putsis, Jr. *Marketing-Mix Variables and the Diffusion of Successive Generations of a Technological Innovation*, *Journal of Marketing Research*, Volume 38, Number 4 November 2001
110. Pasinetti LL (1981) *Structural change and economic growth—a theoretical essay on the dynamics of the wealth of nations*. Cambridge University Press, Cambridge
111. Petia Sicea, Erik Mosekildeb, Alfredo Moscardinic, Kevin Lawlerc and Ian Frenchd, Using system dynamics to analyse interactions in duopoly competition *© 2000 John Wiley & Sons, Ltd. *Syst. Dyn. Rev.* 16, 113–133, (2000)
112. Rich, K.M. and Ross, R.B. (2006). "The application of system dynamics models to high-value agricultural value chains in developing countries," Working paper.
113. Rosenberg, 1976. Rosenberg, N., 1976. *Perspectives on Technology*. Cambridge University Press, Cambridge.
114. Robert Owen, Alfred Ntoko, Ding Zhang and June Dong, Texas A&M University – Texarkana, P.O. Box 5518, Texarkana, TX 75505-5518, USA
115. Roshan S. Gaonkar and N. Viswanadham, Analytical Framework for the Management of Risk in Supply Chains, *IEEE Transactions on automation science and engineering*, VOL. 4, NO. 2, APRIL 2007 265
116. Rogers, E.M. (1994). *A history of communication study: A biographical approach*. New York: Free Press.
117. Rogers, Everett M. <http://nml.gov/pnr/eval/rogers.html>, December 10, 1997
118. Rogers Everett M., Una E. Medina, Mario A. Rivera and Cody J. Wiley, Complex adaptive system and the diffusion of innovations, *The Innovation Journal: Volume 10(3)*, article 30. University of New Mexico

119. Renana Peres, Vijay Mahajan and Eitan Muller (2010), "Innovation Diffusion and New Product Growth: A Critical Review and Research Directions," *International Journal of Research in Marketing*, forthcoming.
120. Rose N and Joskow P (1990) The diffusion of new technologies: evidence from the electric utility industry, *Rand Journal of Economics* 21(3): 354-373.
121. Robinson and Markandya, 1973. S. Robinson and A. Markandya, Complexity and adjustment in input-output systems. *Oxford Bulletin of Economics and Statistics* 35 (1973).
122. Rosenberg, 1982. Rosenberg, N., 1982. Inside the Black Box: Technology and Economics. Cambridge University Press, Cambridge.
123. Rogers, E M. 1995. *Diffusion of Innovations*, Fourth Edition. New York, The Free Press.
124. Rogers, E. M. 2003. *Diffusion of Innovations* (5th Edition). New York: Free Press.
125. Rogers, E.M., 1962. *Diffusion of Innovations*. The Free Press, New York.
126. R. Pearl. *The Biology of Population Growth*. Alfred A. Knopf, New York (1925).
127. Richard G. Newell, Resources for the Future, Energy Efficiency Challenges and Policies
128. Satsangi, P.S, "Integrated Urban Energy-Economy Environment-Transportation System Modelling And Simulation With Particular Reference to Soft-computing", Transportation Systems - Status Directions, Phoenix Publications, IIT New Delhi Conference, pp. 369-384, 2002.
129. Starr PJ. 1980. Modeling issues and decisions in system dynamics. *TIMS Studies in the Management Sciences* 14: 45-59.
130. Schumpeter JA, The Creative Response in Economic History, *Journal of Economic History* VII (November): 149-159, 1947.
131. [Schumpeter, Joseph](#), *The Theory of Economic Development*. Cambridge, MA: Harvard University Press, 1934.
132. Stoneman P (2002) *The Economics of Technological Diffusion*. Oxford: Blackwell Publishers.
133. Stoneman P (1995) *The Handbook of Economics of Innovation and Technological Change*, Blackwell, Cambridge MA. Wright D (2001) *Voice over Packet Networks*. New York, Wiley.
134. Skipper, J. B., J.B. Hanna, and B.J. Gibson (2007), "Applying Contingency Planning Processes to Supply Chain Disruptions: A Service Provider's Response to Hurricane Katrina," *Journal of Transportation Management*, 18(2), 51-63.
135. Sabine Schmidt and Daniel Baier System dynamics based prediction of new product diffusion, Germany
136. Solberg, J. (1992) "The power of simple models in manufacturing", *Manufacturing systems-Foundations of World-Class Practice*, J. Hein and W. Compton (eds.), Washington, USA National Academy of Engineering Press, pp215- 223.
137. Smith et al., 2007 G.E. Smith, K.J. Watson, W.H. Baker and J.A. Pokorski II, A critical balance: collaboration and security in the IT-enabled supply chain, *International Journal of Production Research* 45 (11) (2007), pp. 2595–2613.
138. [Swaminathan, J.M.](#), Smith, S.F. and Sadeh, N.M., 1998. Modeling supply chain dynamics: multiagent approach. *Decision Sciences* 29, pp. 607–632.
139. Sterman, John D.: *Business Dynamics – Systems Thinking and Modeling for a Complex World*, Boston 2000,
140. [Sidoro Romero, Erik Dietzenbacher, Geoffrey J. D. Hewings](#), Fragmentation and Complexity: Analyzing Structural Change in the Chicago Regional Economy, *Fragmentación y complejidad: análisis del cambio estructural en la economía de la región de Chicago*, Universidad de Sevilla, 2009, isbn: 1576-0162
141. Seung-jun Yeon a,T, Sang-hyun Park a, Sang-wook Kim b, Technological Forecasting & Social Change 73 (2006) 648–665A dynamic diffusion model for managing customer's expectation and satisfaction, *International Journal of Computer Applications in Technology* Volume 37 , Issue 3/4 (March 2010) Pages: 268-278 : 2010
142. Swaminathan J.M., Quantitative analysis of emerging practices in supply chains, Doctoral Dissertation, GSIA, Pittsburgh, PA, 1996
143. Shang-Tae Yee, Jeffrey Tew, (Patent1), Modeling Supply chain General Motors Corporation, Detroit, MI, US
144. Skiadas, C. H. (1986). Innovation diffusion models expressing asymmetry and/or positively or

- negatively influencing forces. *Technological Forecasting and Social Change*, 30, 313–330.
145. Simon, Herman, and Karl-Heinz Sebastian. (1987). "Diffusion and Advertising: The German Telephone Company," *Management Science*, 33(April), 451–466.
 146. Stoneman, Paul (2002). *The Economics of Technological Diffusion*. Cambridge, MA: Blackwell.
 147. Skiadas, C. H. (2005). Mathematical models of Chaos. In P. Stavroulakis (ed.), *Chaos applications in Telecommunications*. New York: Taylor and Francis.
 148. Soo Wook Kim , A Dynamic Analysis of Technological Innovation Using System Dynamics Seoul National University , Seoul, KOREA.
 149. Skiadas, C. H., Rompogiannakis, G., Apostolou, A., & Dimoticalis, J. (2005). Chaotic aspects of a generalized rational model. *Proceedings of the XIth international symposium on applied stochastic models and data analysis, ASMDA 2005*, 17–20. 2005. Brest, France.
 150. S. Kalish, A new product adoption model with pricing, advertising and uncertainty. *Mgmt Sci.* 31, 1569-1585 (1985).
 151. Speller, Thomas, Value chain modelling using system dynamics, Massachusetts Institute of Technology, Luis Rabelo, and Albert Jones, University of Central Florida, Florida 32816, USA, 2003
 152. Temkin B (2002) Building a Collaborative Supply Chain. ASCET: Achieve Supply Chain Excellence through Technology. 4: 2002
 153. TOWHIDUL ISLAM The Effect of Technical Efficiency on Waiting Times* *Journal of Productivity Analysis*, 18, 161–169, 2002
 154. Talukdar D, Sudhir K. & Ainslie A, 2002. Investigating new product diffusion across products and countries. *Marketing Science* 21 (1): 97-114
 155. Vaibhav Goel, Heather D. Levy, Melissa J. Perri, Joseph L. Strandberg, Nicholas Vargas, *Business of Science and Technology Initiative, Cornell University, Ithaca, NY*
 156. Van Den Bulte, Christophe, and Gary Lilien. (1997) "Bias and Systematic Change in the Parameter Estimates of Macro-Level Diffusion Models." *Marketing Science*, 16 (4), 338–353.
 157. Van Den Bulte, Christophe, and Stefan Stremersch. (2004) "Social Contagion and Income Heterogeneity In New Product Diffusion: A Meta-Analytic Test." *Marketing Science*, 23 (4),
 158. www. valuebasedmanagement.net
 159. Warner, "The Need for some Innovative Concepts of Innovation: Examination of Research on the Diffusion of Innovations," 2003.
 160. Workshop proceedings, "The 10-50 Solution: Technologies and Policies for a Low-Carbon Future." The Pew Center on Global Climate Change and the National Commission on Energy Policy. Pew Center/NCEP 10-50 Workshop
 161. WY Hung, S Kucherenko, NJ Samsatli and N Shah, A flexible and generic approach to dynamic modelling of supply chains, *Journal of the Operational Research Society* (2004) Operational Research Society Ltd.
 162. X. Tingyan, A combined Growth Model for Trend Forecasts. *Technol. Forecast. Soc. Change* 38, 175--86 (1990).
 163. Young, H. (1998). *Individual Strategy and Social Structure: An Evolutionary Theory of Institutions*. Princeton, NJ and Oxford: Princeton University Press.
 164. [Yong Tan , Vijay S. Mookerjee, Allocating Spending Between Advertising and Information Technology in Electronic Retailing, Management Science, v.51 n.8, p.1236-1249, August 2005](#)
 165. Zhang and David Dilts, System dynamics of supply chain network organization structure, *Information systems and e-business management* , Springer-Verlag, 187-206, 2004.

Appendix: A: System Model Equations (Telecom Sector) :

GDP & INFRASTRUCTURE SECTOR

Accum_Infrastructure(t) = Accum_Infrastructure(t - dt) + (Infra_Invest) * dt

INIT Accum_Infrastructure = 77000

INFLOWS:

Infra_Invest = External_Funds + RevenueInfra_Ratio

External_Funds(t) = External_Funds(t - dt)

INIT External_Funds = 24000

$GDP(t) = GDP(t - dt) + (Increment) * dt$
 INIT GDP = 1170000
 INFLOWS:
 Increment = GDP*GR
 $Operators(t) = Operators(t - dt) + (ENTRY - EXIT) * dt$
 INIT Operators = 10
 INFLOWS:
 ENTRY = Operators*50/100
 OUTFLOWS:
 EXIT = Operators*10/100
 $Towers_Infra(t) = Towers_Infra(t - dt) + (Construction - Mortality) * dt$
 INIT Towers_Infra = 200000
 INFLOWS:
 Construction = CR+Infra_Invest/Infra_Invest
 OUTFLOWS:
 Mortality = MR
 ARPO = Total_ARPU/Operators
 CR = STEP(Towers_Infra*75/100,.50)
 GR = CGROWTH(8.4)
 GR_GDP_Ratio = Accumulated_GR*5.6/100+STEP(Accumulated_GR*9.8/100, .75)
 MR = Towers_Infra*CGROWTH(7)
 RevenueInfra_Ratio = ARPU_Gain*5/100
 MARKET SECTOR
 $CDMA(t) = CDMA(t - dt) + (CDMA_Base) * dt$
 INIT CDMA = 199
 INFLOWS:
 CDMA_Base = Adopters*32/100
 $GSM(t) = GSM(t - dt) + (GSM_Base) * dt$
 INIT GSM = 422
 INFLOWS:
 GSM_Base = Adopters*68/100
 $GSM_Firm_Market_Share(t) = GSM_Firm_Market_Share(t - dt) + (Gain - Churn) * dt$
 INIT GSM_Firm_Market_Share = 0
 INFLOWS:
 Gain = MS_Ratio
 OUTFLOWS:
 Churn = GSM_Firm_Market_Share*6/100
 $Mobile_Teledensity(t) = Mobile_Teledensity(t - dt) + (Share_Gain) * dt$
 INIT Mobile_Teledensity = 575
 INFLOWS:
 Share_Gain = Density_Ratio
 TELE_GDP = Mobile_Teledensity*3/GDP*1
 R&D SECTOR
 $Gross_Telecom_R\&D(t) = Gross_Telecom_R\&D(t - dt) + (Investment_2) * dt$
 INIT Gross_Telecom_R&D = 11500
 INFLOWS:
 Investment_2 = GDP_R&D_Ratio
 $Industry_R\&D(t) = Industry_R\&D(t - dt) + (Investment) * dt$
 INIT Industry_R&D = 4544
 INFLOWS:
 Investment = Revenue_R&D_Ratio
 GDP_R&D_Ratio = GDP*CGROWTH(1.3)
 Revenue_R&D_Ratio = ARPU_Gain*15/100+STEP(ARPU_Gain*15/100,.50)

REVENUE & PROFITABILITY SECTOR
 $Accumulated_GR(t) = Accumulated_GR(t - dt) + (ARPU_Gain) * dt$
 INIT Accumulated_GR = 43000
 INFLOWS:
 ARPU_Gain = CAGR_ratio
 $CDMA_REVENUE(t) = CDMA_REVENUE(t - dt) + (Inflow2 - Annual_Decline2) * dt$
 INIT CDMA_REVENUE = 5227
 INFLOWS:

Inflow2 = CDMA_Base*1188/45
 OUTFLOWS:
 Annual_Decline2 = CDMA_REVENUE-Inflow2*26/100
 ECONOMIC_VALUE(t) = ECONOMIC_VALUE(t - dt) + (Appreciate - Value_Loss) * dt
 INIT ECONOMIC_VALUE = 100000
 INFLOWS:
 Appreciate = Appreciation_ratio
 OUTFLOWS:
 Value_Loss = Loss_ratio
 GSMREVENUE(t) = GSMREVENUE(t - dt) + (Inflow - Annual_Decline) * dt
 INIT GSMREVENUE = 23069
 INFLOWS:
 Inflow = GSM_Base*2460/45
 OUTFLOWS:
 Annual_Decline = GSMREVENUE-Inflow*35/100
 Profitability(t) = Profitability(t - dt) + (Income - Cost) * dt
 INIT Profitability = 12150
 INFLOWS:
 Income = Total_ARPU
 OUTFLOWS:
 Cost = Total_ACPU
 Appreciation_ratio = Accumulated_GR*2+STEP(-Value_Loss,.25)
 CAGR_ratio = Accumulated_GR*CGROWTH(18)
 Loss_ratio = ECONOMIC_VALUE*7/100+STEP(ECONOMIC_VALUE*8/100,.25)
 MS_Ratio = GSM_Base*26/100
 Total_ACPU = Adopters*26
 Total_ARPU = CDMA_REVENUE+GSMREVENUE+G3REVENUE
 TELECOM ADOPTION SECTOR
 Adopters(t) = Adopters(t - dt) + (ADOPTION) * dt
 INIT Adopters = 584
 INFLOWS:
 ADOPTION = Immitation+Innovation+Adopters
 POPULATION(t) = POPULATION(t - dt) + (ADDITION) * dt
 INIT POPULATION = 1150
 INFLOWS:
 ADDITION = POPULATION/Growth
 POT_ADOPTERS(t) = POT_ADOPTERS(t - dt) + (POTAD - ADOPTION) * dt
 INIT POT_ADOPTERS = 0
 INFLOWS:
 POTAD = POP_minus_ADOP
 OUTFLOWS:
 ADOPTION = Immitation+Innovation+Adopters
 Growth = POPULATION*Growth_Perc
 Growth_Perc = 0.013
 Immitation = POTAD*Adopters*Immit_Coeff/POPULATION
 Immit_Coeff = .554
 Innovation = POTAD*Innov_Coef
 Innov_Coef = .0003
 POP_minus_ADOP = POPULATION-Adopters
 Not in a sector
 G3BASE(t) = G3BASE(t - dt)
 INIT G3BASE = 8
 G3REVENUE(t) = G3REVENUE(t - dt) + (Earn - Expen) * dt
 INIT G3REVENUE = 2000
 INFLOWS:
 Earn = { Place right hand side of equation here... }
 OUTFLOWS:
 Expen = 0
 ARG3 = G3BASE*250

Appendix: B

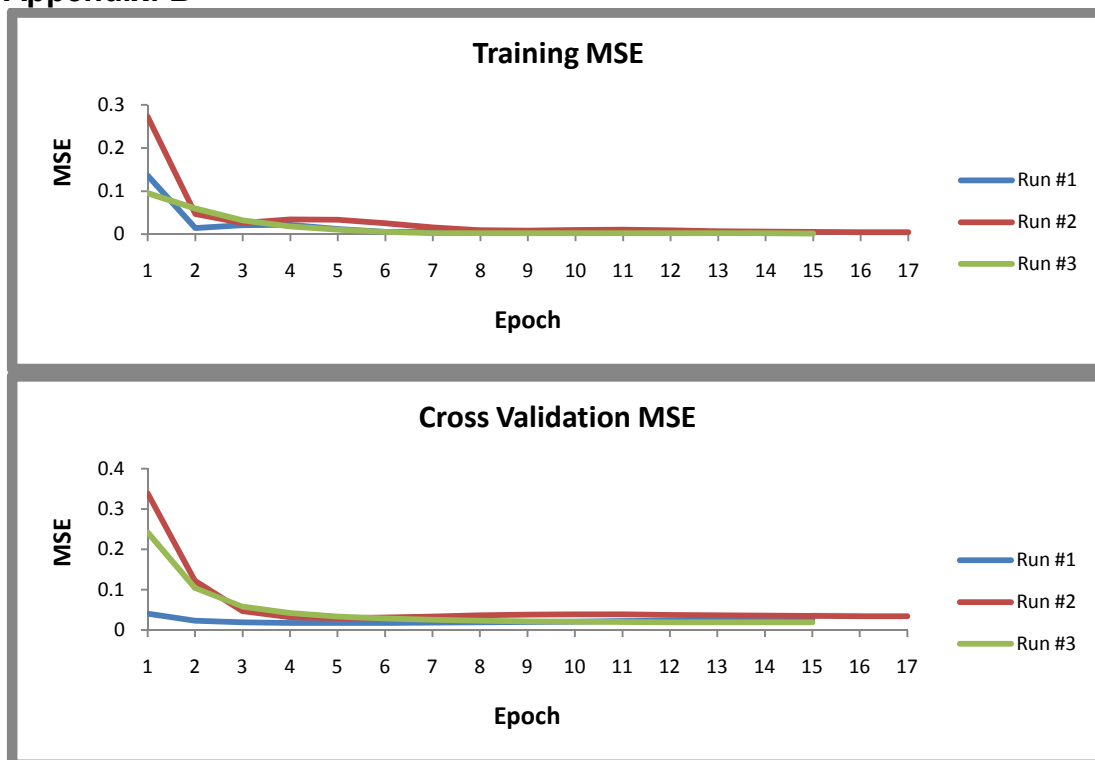

<i>All Runs</i>	<i>Training Minimum</i>	<i>Training Standard Deviation</i>	<i>Cross Validation Minimum</i>	<i>Cross Validation Standard Deviation</i>
Average of Minimum MSEs	0.000142379	1.67593E-05	0.012850877	0.00293633
Average of Final MSEs	0.000142379	1.67593E-05	0.012850877	0.00293633

<i>Best Networks</i>	<i>Training</i>	<i>Cross Validation</i>
Run #	2	3
Epoch #	1000	1000
Minimum MSE	0.000126158	0.009524197
Final MSE	0.000126158	0.009524197